



# TITAN

User manual

# Table of Contents

1. Introduction.....	3
2. Basics and safety summary .....	4
2.1. Safety .....	4
2.2. Installation.....	5
2.3. Usage.....	7
3. Firmware editions .....	9
4. TITAN Kits .....	13
5. GATE Control Station (GCS).....	15
5.1. Connecting TITAN to USB-Link and PC, MAC or Android Device.....	15
5.2. Status tab .....	18
5.3. Settings tab .....	19
5.4. Sensors tab.....	22
5.5. Statistics tab.....	24
5.6. Diagnostic Trouble Codes (DTC) tab.....	25
6. TITAN V2 .....	26
6.1. TITAN V2 Advanced Set.....	27
6.2. TITAN V2 Basic Module.....	28
6.3. Installation safety .....	29
6.4. Installation.....	34
7. TITAN V3 .....	51
7.1. TITAN Advanced Set .....	52
7.2. TITAN Basic Module.....	53
7.3. Installation safety .....	54
7.4. Installation.....	56
8. TITAN V2 NGRS.....	72
8.1. TITAN Advanced Set .....	73
8.2. TITAN Basic Module.....	74
8.3. Installation safety .....	75
8.4. Installation.....	78
9. Functions .....	95
10. Legal Notice.....	100
10.1. PRODUCT DISPOSAL INSTRUCTIONS.....	101
10.2. CERTIFICATE OF CONFORMITY .....	101

# 1. Introduction

Congratulations on your new TITAN, the first in the world drop-in AEG Control System with optical sensors. TITAN will transform your AEG into an advanced training weapon system. Gain a tactical advantage thanks to the extremely fast trigger response, with an option of adjusting the AEG for each mission with multiple functions. Give your AEG a new lease of life!

Configure your TITAN in the field or simply update the firmware and adjust the settings using the USB-Link and the GATE Control Station app which is available for PC/MAC and Android devices.

With this guide, you will get familiar with all the functions and learn how to use them.

## 2. Basics and safety summary

Please read this manual before using the device to ensure safe and proper use.

Information contained in this document is subject to updating without notice. Please check if you have downloaded the latest manual from the Technical Support section of our website:

<https://www.gatee.eu/technical-support/manuals>

The Product Warranty Form is also available there:

<https://www.gatee.eu/technical-support/warranty>

GATE Enterprise spółka z ograniczoną odpowiedzialnością sp. k. does not take any responsibility for damages, injuries and accidents resulting from the use of this product or the use of Air Electric Gun with the product installed. In case you have any difficulties while installing or using this product, we recommend to contact us. Our support team will answer all your questions and send you some hints.

In order to contact GATE, you can:

- a) email us at [titan@gatee.eu](mailto:titan@gatee.eu)
- b) contact us via Facebook: [www.facebook.com/gatee](http://www.facebook.com/gatee)
- c) call (+48) 122-100-523



### Warning

Situations that could cause injury to yourself and others.



### Caution

Situations that could cause damage to your device or other equipment.



### Notice

Notes, usage tips, or additional information.

### 2.1. Safety



#### Notice

We recommend that this product should be installed by an experienced airsoft service. Before starting installation process, please ensure that your AEG is empty and there are no BBs inside.



#### Warning

Incorrectly connecting positive and negative battery terminals will cause immediate damage to the drop-in module what is not covered by the warranty and it can lead to fire, burn or even battery explosion.

**Warning**

Stay careful to prevent short circuiting the battery as the consequences can be very dangerous (fire, battery explosion, burn).

## 2.2. Installation

**Warning**

Before starting installation process, please ensure that your AEG is empty and there are no BBs inside.

**Caution**

The incorrect installation may result in sensors' damage what is not covered by the warranty.

**Caution**

Connectors should be bent according to the photo below. Bending connectors in the opposite direction may cause them to break.





### Notice

TITAN V2 and V3 do not support the Infinite torque-up gears.  
TITAN V2 NGRS supports the Infinite torque-up gears.



V2 

V3 

V2 NGRS 



### Notice

Do not use too much grease. Excessive grease may cover gaps between teeth what will cause improper cycle detection.

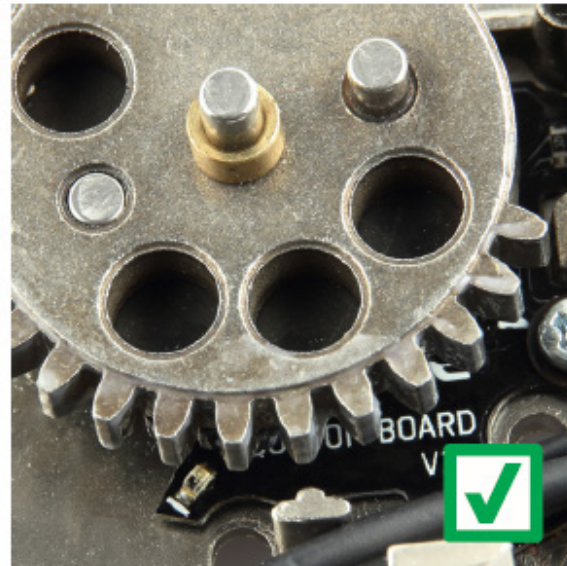

### Notice

For your own safety, you should install an additional fuse between the battery and the drop-in module. The fuse should be placed very close to the battery. It will protect the battery in case of: (1) incorrectly connecting positive and negative battery terminals; (2) shorting the power cords which connect battery and TITAN; (3) mechanical damage to the drop-in module.

## 2.3. Usage



### Warning

Do not attempt to connect the battery when the barrel of your AEG is directed toward you, another person or an animal.



### Notice

You should program your TITAN before the first use.



### Notice

TITAN requires first-time calibration of sensors what can be performed only with USB-Link.



### Notice

Check the availability of TITAN firmware updates using the most recent GCS app: <https://www.gatee.eu/gcs> . Using the most recent firmware versions ensures stable functioning of the device and allows for taking advantage of all its features.



### Notice

When you use the auto cell detection, ensure that your battery is charged. The cell number may be incorrectly detected if your battery is discharged.



### Notice

Before an airsoft game, we suggest to check the most recent configuration and delete the registered Diagnostic Trouble Codes (DTC).



### Caution

Prevent the USB-Link and the small end of the cable from contact with conductive materials (e.g. dust, liquid, metal powder).



### Warning

Too high trigger sensitivity might cause accidental shooting.



### Warning

When an airsoft gun is not in use, its magazine must be detached or kept empty with no BBs inside.



### Notice

When an airsoft gun is not in use, its battery must be disconnected.



### Warning

Do not store or carry flammable liquids, gases, or explosive materials in the same compartment as the device, its parts, or accessories.

**Caution**

The device covers must not be removed by the user (e.g. foil or heat shrink tube).

**Notice**

Avoid using your device near strong electromagnetic fields or when electrostatic discharges such as lightning occur in the atmosphere.



### 3. Firmware editions

The TITAN is currently available in two firmware editions: BASIC and ADVANCED. In the future, the EXPERT edition will be also available. Thanks to the firmware editions, you do not need to replace a drop-in unit - which is inside your AEG - to get more functions. Also, you do not have to pay for functions that you do not need.

#### BASIC

The best for those who prefer simplicity but require highest quality. Economic version with limited number of functions.

#### ADVANCED

The best for those who like complex solutions. Advanced version with wide variety of functions. It enables access to the Statistics and TITAN World Rankings.

In order to upgrade your TITAN firmware from BASIC to ADVANCED, you need to purchase the upgrade. Follow the steps on the website: [www.gatee.eu/editions](http://www.gatee.eu/editions) or use GCS App for Android devices. The upgrade will be available for installation immediately after payment.

TITAN™ Firmware edition	BASIC	ADVANCED
Fire selector mode	3 modes	6 modes
Trigger sensitivity adjustment	✓	✓
Cycle detection	✓	✓
Burst	3-round	2 / 3 / 4 / 5 / 8 / 10-round
Burst mode	FULL	FULL / TRIGGER
Pre-cocking	✗	✓
ROF control	✗	✓
Sniper delay	✗	✓
Battery protection	✓	✓
Low battery warning	✓	✓
Equalizer	✗	✓
AUG mode	✓	✓
Manual active brake settings	✓	✓
Statistics & rankings	✗	✓
Diagnostics	✓	✓
Firmware update	✓	✓
Firmware upgrade	One-time payment for higher edition	

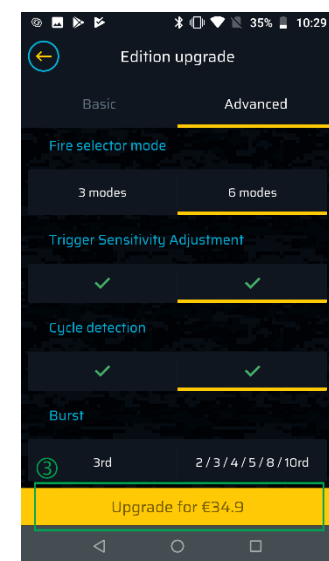
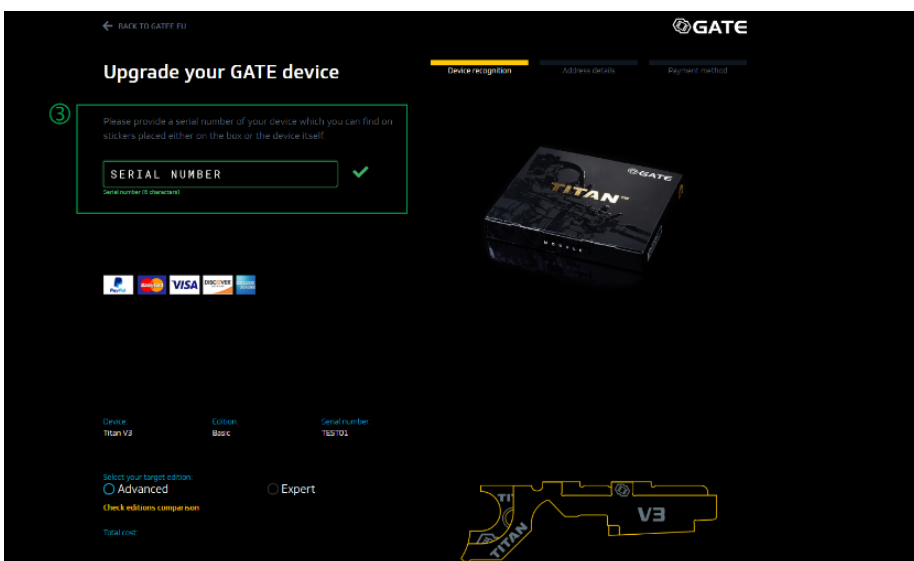
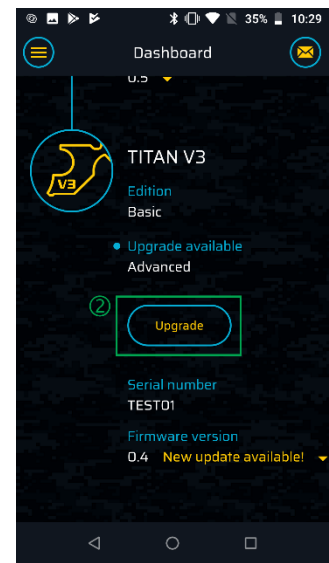
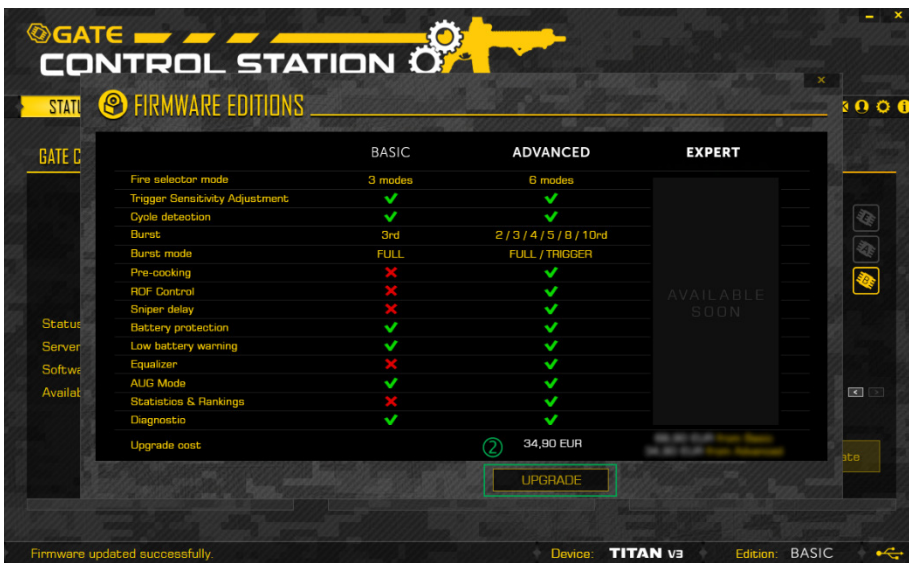
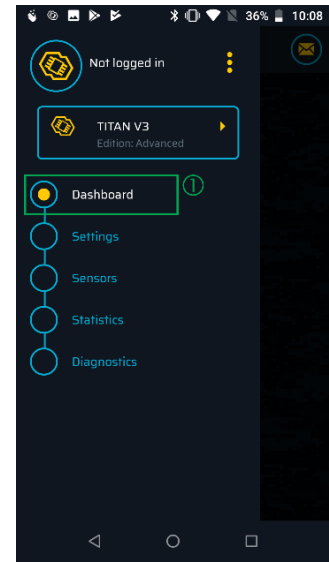

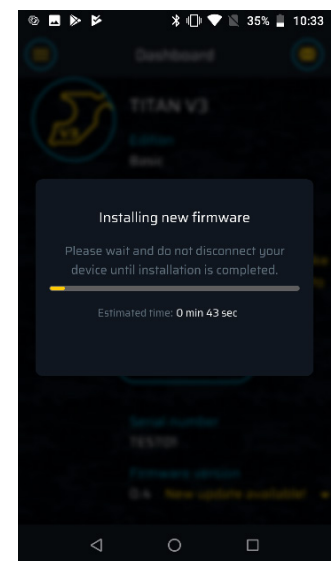
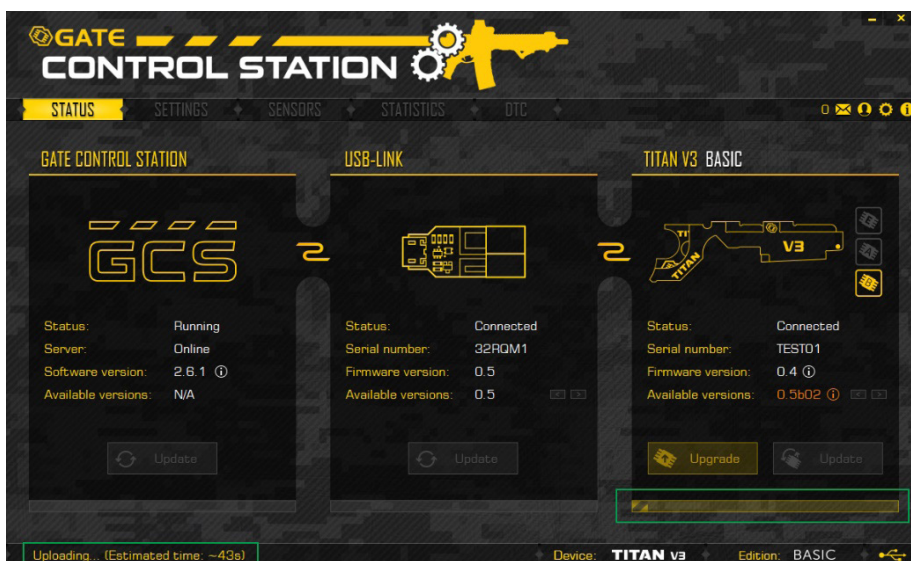
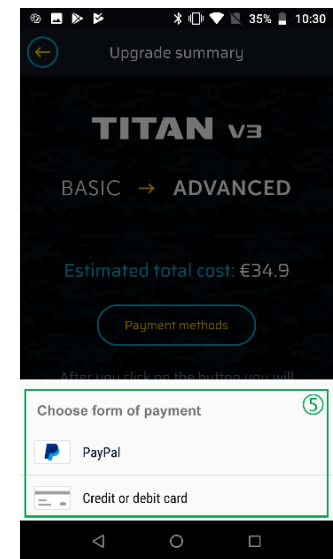
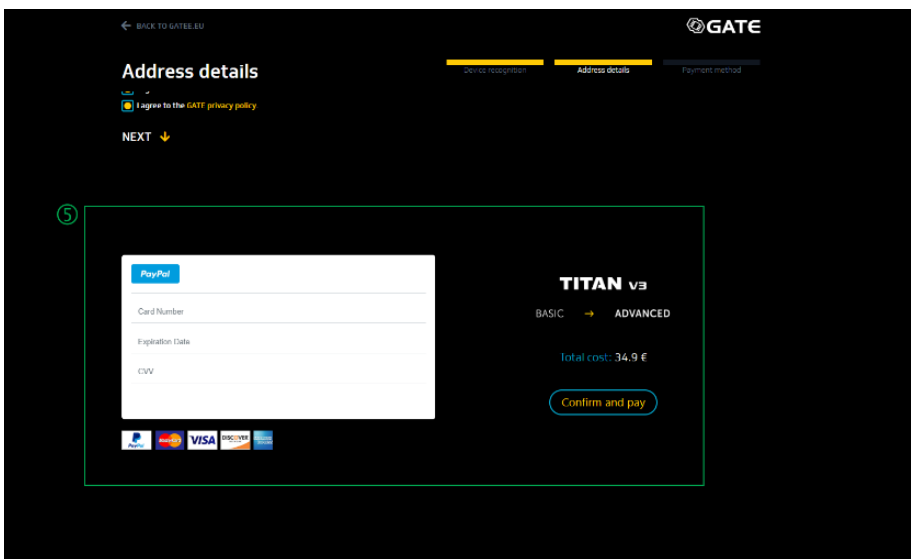
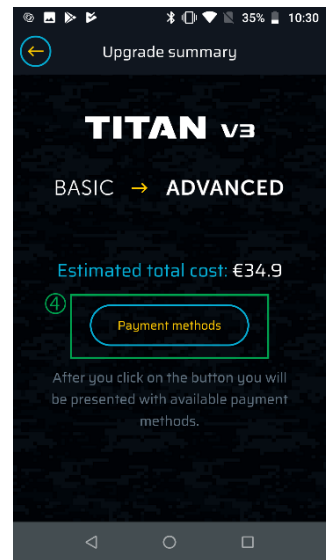
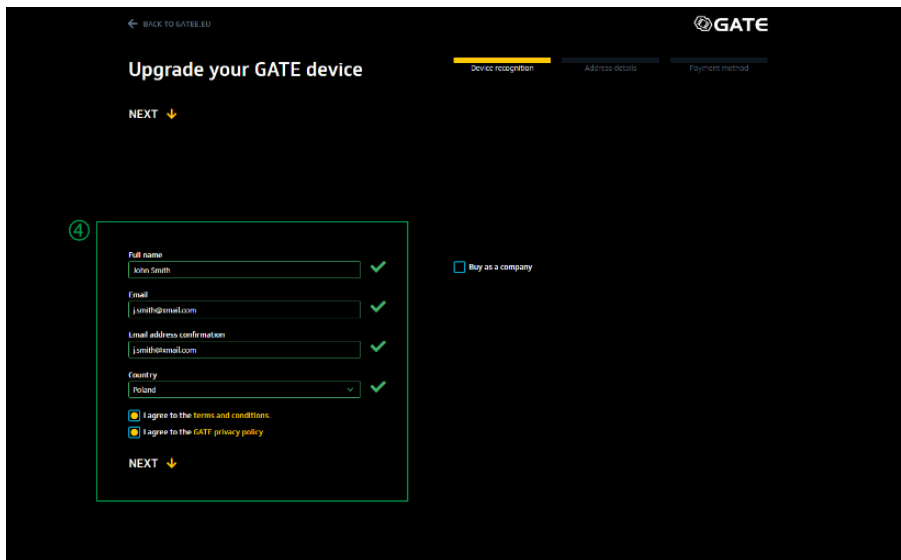

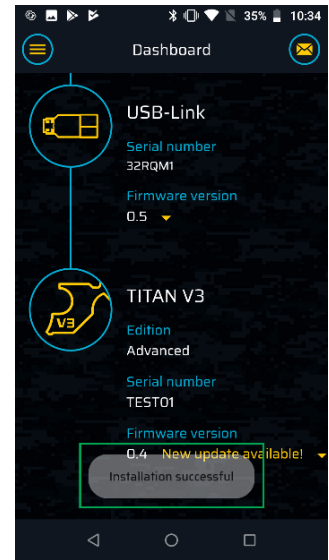
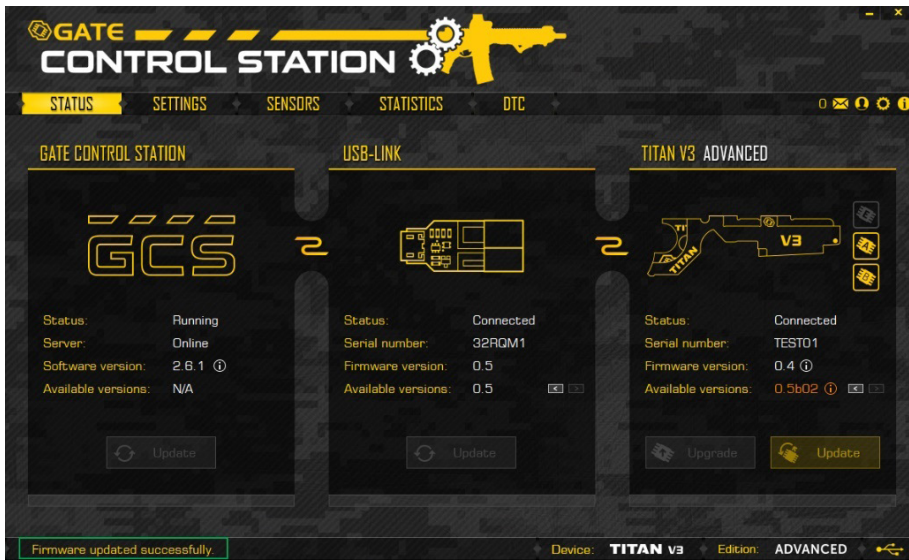

## 4. TITAN Kits

At this moment, TITAN is available for three different types of gearboxes. There is:

- TITAN V2 which is compatible with most V2 gearboxes
- TITAN V3 which is compatible with most V3 gearboxes
- TITAN V2 NGRS which is compatible with Tokyo Marui V2 NGRS gearboxes

Furthermore, TITAN V2 and TITAN V2 NGRS are divided in two types. Depending on where you keep the battery, you can choose between FRONT and REAR wiring.

TITAN V3 has one universal type of wiring. If you have battery in buttstock, you can use additional buttstock extension.

All the TITANs are available in two sets: **Advanced Set** and **Basic Module**.

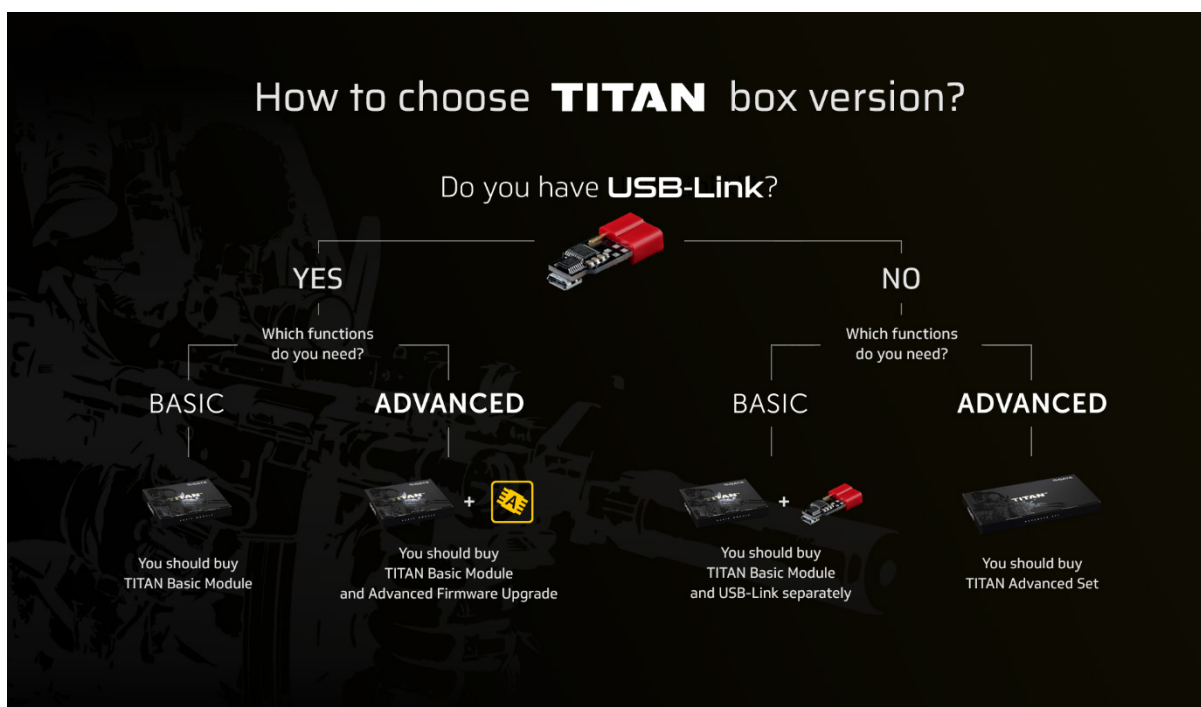

### Case 1

1. Do you have USB-Link? NO.
2. Do you prefer ADVANCED firmware or BASIC firmware edition? ADVANCED.
3. You should buy TITAN Advanced Set.

### Case 2

1. Do you have USB-Link? YES.
2. Do you prefer ADVANCED firmware or BASIC firmware edition? ADVANCED.
3. You should buy TITAN Basic Module and Advanced Firmware Upgrade.

### **Case 3**

1. Do you have USB-Link? NO.
2. Do you prefer ADVANCED firmware or BASIC firmware edition? BASIC.
3. You should buy TITAN Basic Module and USB-Link separately.

### **Case 4**

1. Do you have USB-Link? YES.
2. Do you prefer ADVANCED firmware or BASIC firmware edition? BASIC.
3. You should buy TITAN Basic Module.

## 5. GATE Control Station (GCS)

GATE Control Station enables you to simply update the firmware and adjust the settings using the USB-Link and the GATE Control Station™ app. Thanks to the GCS, you do not have to remember complicated trigger sequences to program your unit. All the features are easily accessible and simple to adjust with just one click.

### Notice

At this moment, GCS can be used on PC/MAC and Android devices. iOS will be supported after release of GATE Bluetooth adapter.

We are constantly improving our applications. Each update brings new features and/or corrections. All the changes are available in our changelog:

<https://gatee.eu/technical-support/changelog>

GCS allows you to:

- update or downgrade TITAN and USB-Link firmware
- upgrade TITAN firmware to ADVANCED or EXPERT edition
- change more than 20 TITAN settings
- calibrate trigger and fire selector
- set trigger sensitivity
- check status of your TITAN sensors
- check statistics of your gun (rate of fire, trigger response etc.)
- check diagnostic trouble codes (DTC)
- contact GATE Support Center (via error report, messenger or phone) [Android]
- receive in-app notifications [Android]

### 5.1. Connecting TITAN to USB-Link and PC, MAC or Android Device.

#### Notice

You need the USB-Link and USB cable to connect TITAN with GATE Control Station.

#### Caution

Prevent the USB-Link and the ends of USB cable from contact with conductive materials (e.g. dust, liquid, metal powder).

#### Notice

Do not remove the device cover.

1. Download and install GATE Control Station: [www.gatee.eu/gcs](http://www.gatee.eu/gcs)



**Notice**

Your Android device must support OTG technology to run GATE Control Station app.



2. Connect the USB-Link to PC, MAC or smartphone using USB cable.

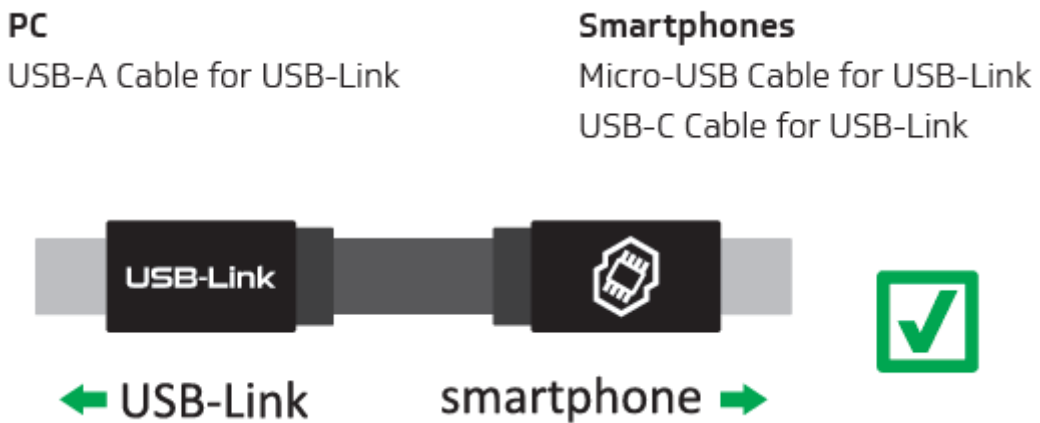

**Notice**

The dedicated GATE 'Micro-USB Cable for USB-Link' has the same connectors on both sides. However, it is very important to which end of cable you connect the USB-Link and smartphone. It will not work reversely.



**Notice**

If your USB-Link cannot be detected, please follow instructions from GATE Control Station screen.

**USB-Link** has a 4-colour LED indicator.



**BLUE (glowing)**

The USB-Link is connected to a PC or smartphone. TITAN is not connected or a PC driver is not installed. You can download the driver here: [www.gatee.eu/drivers](http://www.gatee.eu/drivers)

**BLUE (blinking)**

The USB-Link does not have an installed firmware. Please install the firmware.



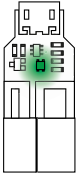

### GREEN (glowing)

The USB-Link is connected to TITAN and PC, MAC or smartphone.

### GREEN (blinking)

The USB-Link is connected to TITAN and PC, MAC or smartphone, but the TITAN does not have an installed firmware. Please install the TITAN firmware.

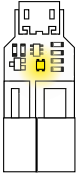

### YELLOW (glowing)

The USB-Link is transmitting data.

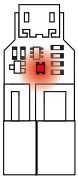

### RED (glowing)

Communication with the TITAN was interrupted while saving settings. The TITAN settings may be transmitted incorrectly. Please check the connection between the USB-Link and the TITAN.

### 3. Connect TITAN to USB-Link.

#### **i** Notice

If your USB-Link cannot detect TITAN, please check if there is the same issue with another PC, MAC or smartphone.

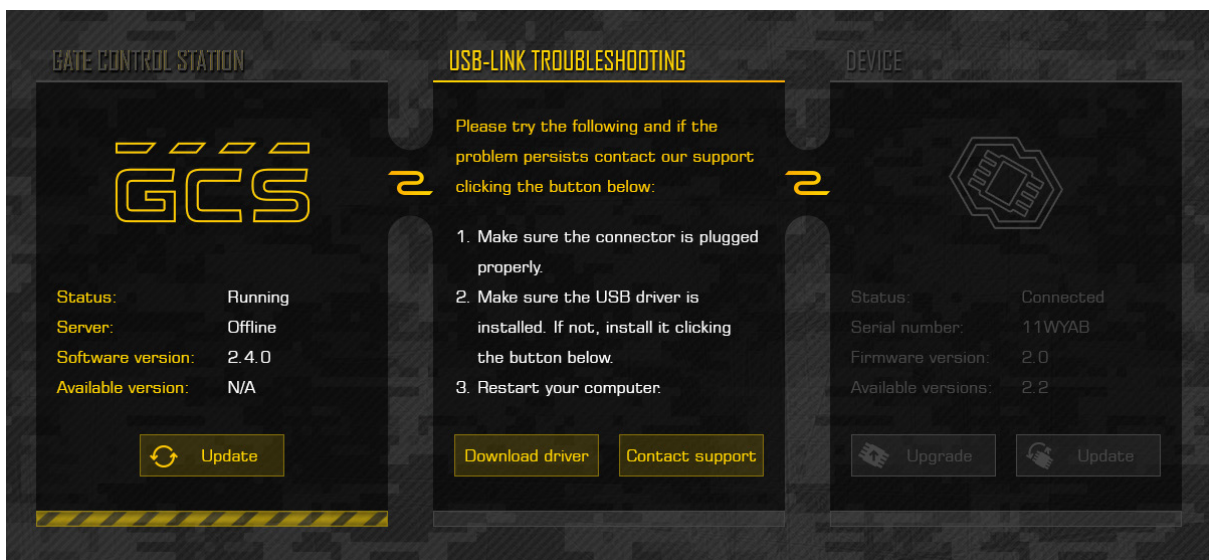

If the problem still occurs, please contact our Support Center. You can:

- email us at [titan@gatee.eu](mailto:titan@gatee.eu)
- contact us via Facebook: [www.facebook.com/gatee](https://www.facebook.com/gatee)
- call (+48) 122-100-523

#### 4. Now you can control TITAN via GATE Control Station.

During the first start you will be asked to create your own profile. It is not obligatory but it will help when you will be contacting our support.

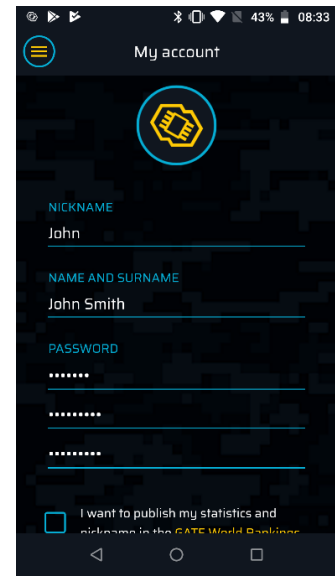
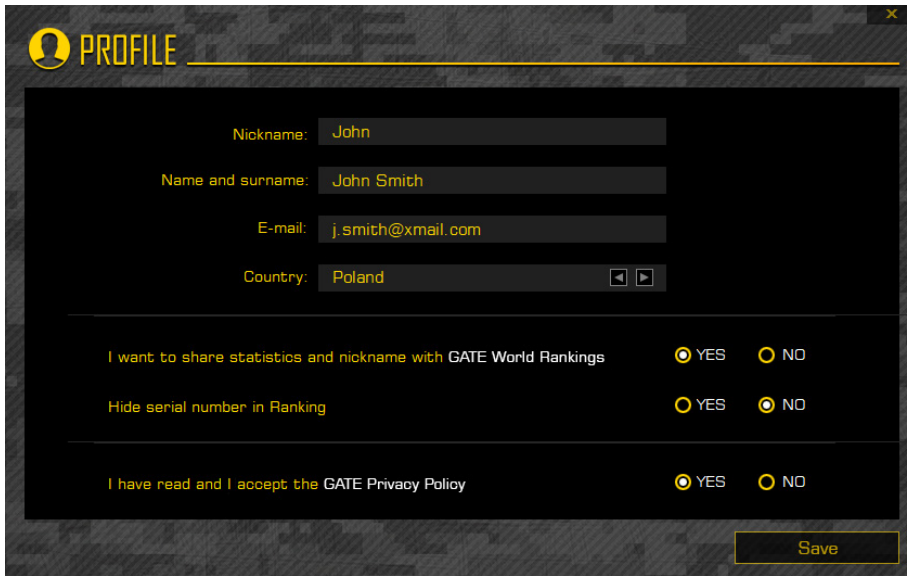

#### 5.2. Status tab

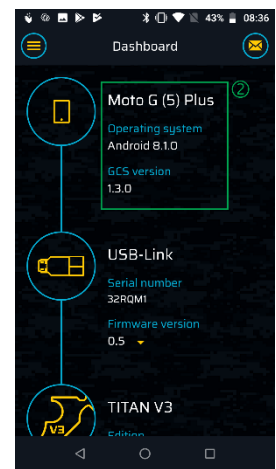
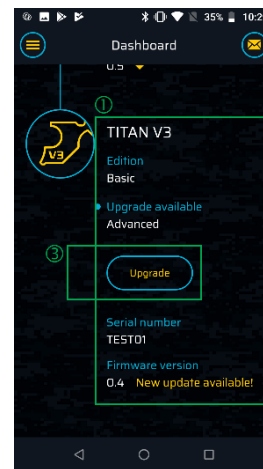

① The status TAB informs you about version, edition, type and serial number of the connected device, ② as well as application version and server status. ③ Here you can simply update or „downgrade your device or upgrade firmware of your unit to ADVANCED or EXPERT edition.

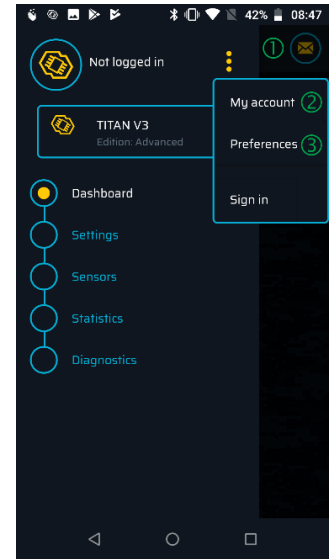
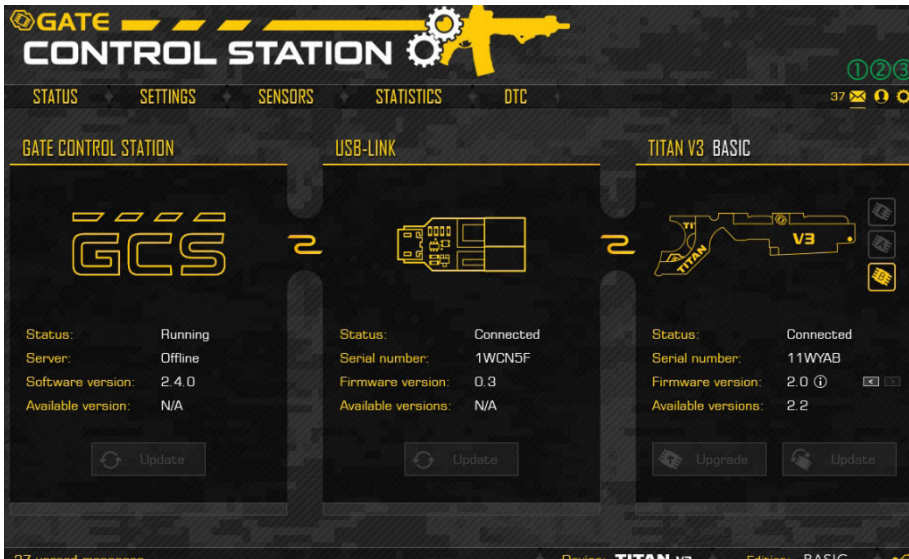

There are four icons in the upper right corner:

- ① Mail - includes messages and newsletter
- ② Profile - allows you to change your privacy settings
- ③ Options - here you can choose the language (future function), switch update interval, turn on/off the autosaving and sounds
- ④ Info - basic legal information

### 5.3. Settings tab

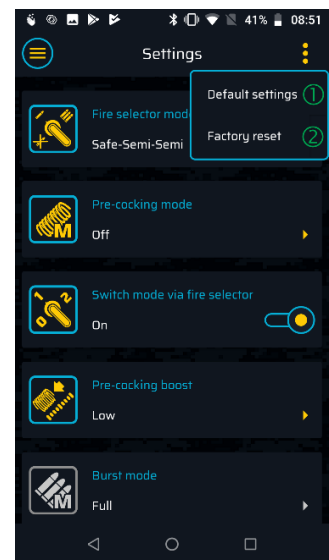

Settings tab was created in order to simplify the configuration of your TITAN.

- ① **Factory reset** – (also called “Hard reset”) restores all default settings, resets your statistics and clears adaptation data.
- ② **Default setting** – restores only default settings.

### ③ Settings tab:

**Fire selector mode** – allows you to choose how your replica will behave on each fire selector position:

- SAFE – replica will not fire after trigger pull
- SEMI – one pull of the trigger will result in only one shot
- BURST – one pull of the trigger enables you to shoot a pre-determined number of BBs, which is very useful in MILSLIM and when using low-caps
- AUTO – pulling the trigger causes uninterrupted\* series of shots until the trigger is released

\*series can be limited by **Round Limit**

**Pre-cocking mode** – allows for initial spring compression, which speeds up the trigger response significantly:

- AUTO MODE – the spring is automatically compressed after each shot
- TRIGGER MODE – slow trigger action compresses the spring, and fast trigger action fires the shot

Please note: using PRE-COCKING increases wear and tear on the gearbox.

**Pre-cocking boost** – determines the strength of spring compression. The highest setting results in the best trigger response, but also mostly increases wear and tear on the gearbox.

If you are facing overspin issue, set **GEAR RATIO** to **HIGH SPEED**.

#### **Burst mode:**

- FULL – every, even the shortest trigger action fires the pre-determined number of rounds
- TRIGGER – releasing the trigger while firing stops the burst sequence.

**Burst** – allows you to set how many BBs will be fired

#### **ROF stabilization:**

- ON – ROF Control uses PWM (Pulse Width Modulation) to decrease ROF. Thanks to this, gearbox works smoothly what decreases wear and tear of AEG internal parts. The percentage value determines the PWM duty cycle and it does not reflect ROF decrease.
- OFF – ROF Control adds breaks between shots to decrease ROF. It gives you more realistic experience. This option set to 50% will significantly reduce the rate of fire.

**ROF control** – enables a reduction in a gun's rate of fire. You use stronger LiPo batteries, and still have a ROF just like in a real gun.

**Sniper delay** – lets you to set delay between each SEMI shots to simulate the delay from reload or recoil. You can set 0.5s, 1s, 2s or 3s delay. By choosing 'VIB' option, you can enable vibration which will inform you when the gun is ready to fire again.

**Battery protection** – modern LiPo and LiFe batteries are very sensitive to over-discharge. The microprocessor monitors the battery voltage constantly. When the voltage drops down to a critical level, it will not allow firing.

**Battery cell** – when the battery voltage drops to the specified level (in relation to one cell), the motor will vibrate. You can set: OFF, 3.2V or 3.4V per cell for LiPo battery and 2.7V or 2.9V per cell for LiFe battery.

**30-Round Limit** – an AEG can continuously fire max. 30 BBs. To fire more BBs, you must release the trigger before. This is protection against trigger jam. Important: in case of emergency, you can also stop firing by switching the fire selector position.

**Cycle detection** – allows to switch OFF or ON the optical gear sensor. Cycle detection OFF can be compared with the “emergency mode” for troubles with gear sensor. Most of TITAN features will be disabled, but you can still shoot on ‘AUTO’.

Thanks to the gear sensor, TITAN precisely detects in which position the cycle should finish. Therefore, even the shortest trigger action produces at least one full cycle.

#### **Equalizer (dynamic trigger point):**

- OFF - to fire the next shot, you need to release the trigger until it reaches the selected trigger sensitivity level
- 2LVL - to fire the next shot, it is enough to release the trigger so as it changes the state of two trigger sensors or ~40% of trigger movement
- 1LVL - to fire the next shot, it is enough to release the trigger so as it changes the state of one trigger sensor or ~20% of trigger movement

1LVL or 2LVL are especially useful when the trigger sensitivity level is very high. Then you do not need to fully release the trigger while quickly firing on SEMI.

**Active brake** - it automatically adjusts the motor’s braking power according to your needs. This prolongs the lifespan of the motor and reduces the heat. Now you can also choose your own value depending on your needs.

**Gear ratio** - to make the PRE-COCKING work with the highest level of precision you should define the gears type in your AEG. Available types: STANDARD, HIGH TORQUE, HIGH SPEED, DSG, 19-TOOTH.

Typical gear ratio settings (excluding DSG and 19-tooth):

- HIGH TORQUE: <15 RPS
- STANDARD: 15-25 RPS
- HIGH SPEED: >25 RPS

If overspin issue occurs, you should switch the gear type to the next level (e.g. STANDARD to HIGH TORQUE).



## Notice

Regional lock designed for German players will disable all the burst and auto options.



## Notice

The DSG and 19-TOOTH gear ratio options are not available for TITAN V2 NGRS.

## 5.4. Sensors tab

Depending on your TITAN model, you will see one of the three screens below.

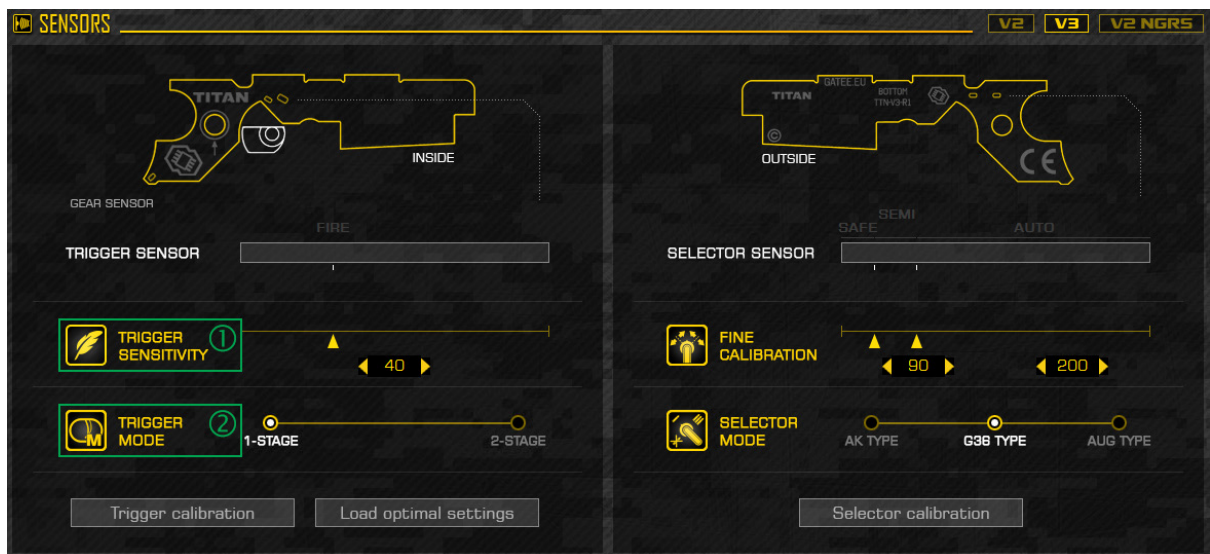
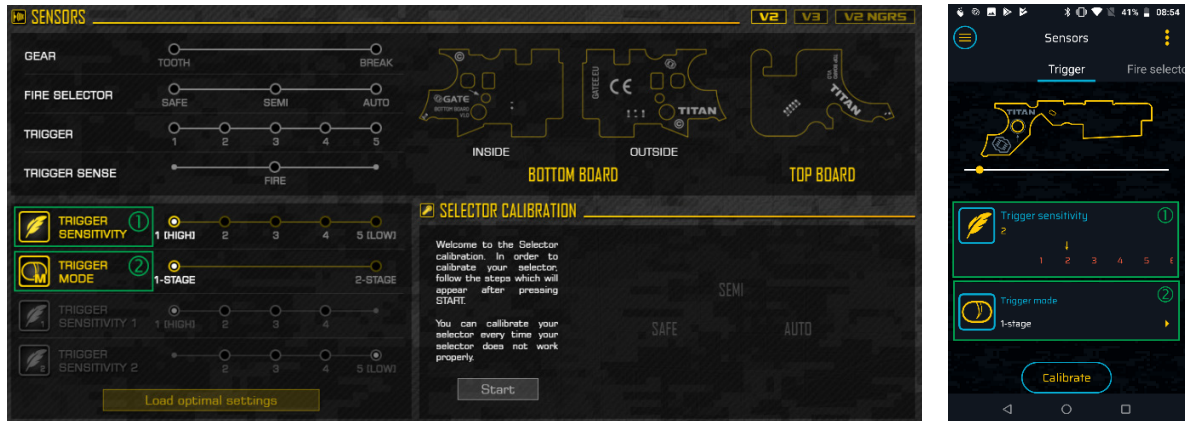



We designed the Sensors TAB in order to let you choose the ① trigger sensitivity or ② trigger mode that is the best for you. Thanks to live view, you do not need to mechanically adjust your trigger. Simply choose the value and check if it suits you.

You will be warned if the trigger sensitivity value reaches extremely low level.

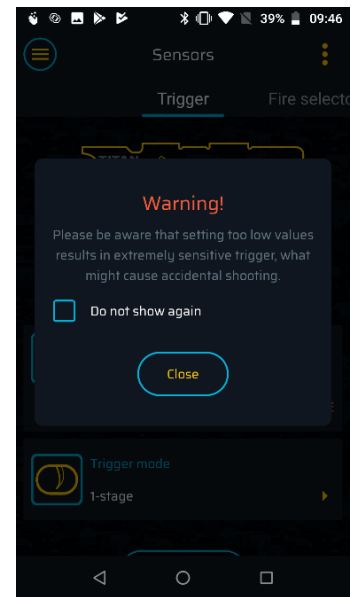
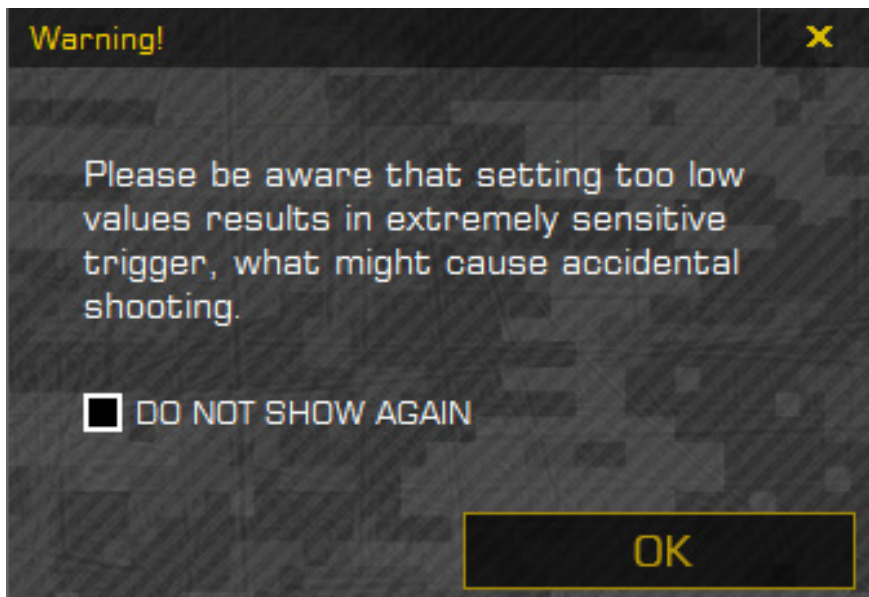

## 5.5. Statistics tab

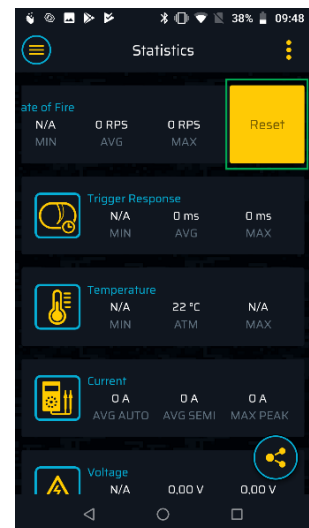

The statistics tab contains main information about your replica performance. You can simply clear each value by clicking “Reset” button. You can also independently reset BB1 and BB2 counter.

TITAN gives you the option to check:

- **Rate of fire** - Minimum, Average, Maximum
- **Trigger response** - Minimum, Average, Maximum
- **Module’s temperature** - Minimum, At this moment, Maximum
- **Motor current** - Average AUTO, Average SEMI, Maximum Peak
- **Battery voltage** - Minimum, Last, Maximum
- **Number of fired BBs** - BB1, BB2, TOTAL

### Notice

Statistics are saved every ten seconds. If you want to save your statistics immediately, switch the fire selector to SAFE.



## 5.6. Diagnostic Trouble Codes (DTC) tab

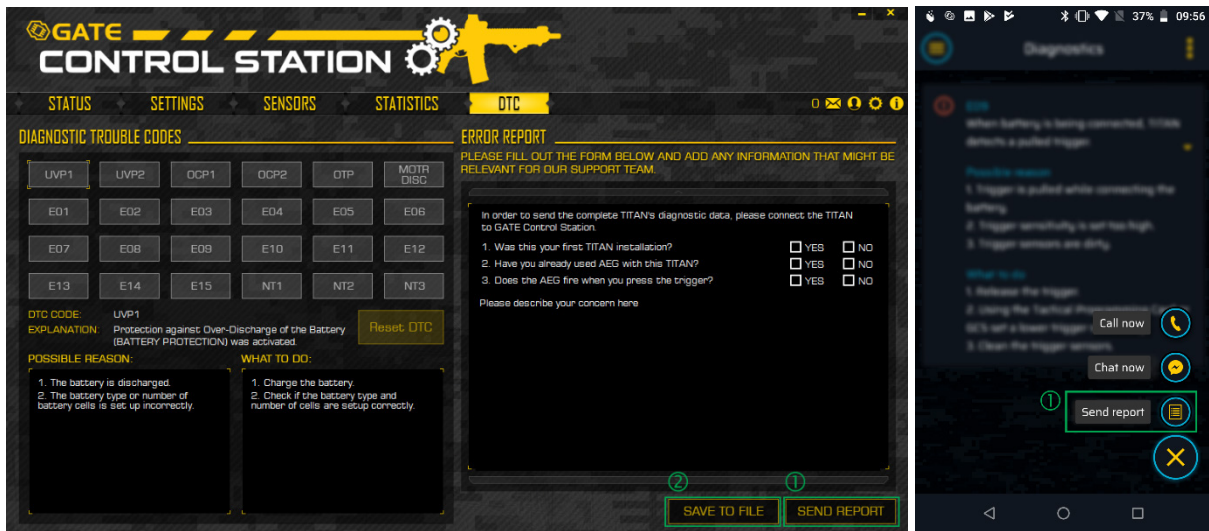

This TAB will help you to troubleshoot your replica in case of any issue. If you need additional help, you can contact our Support Center using ① “SEND REPORT” button, or save the report using ② “SAVE TO FILE” button.

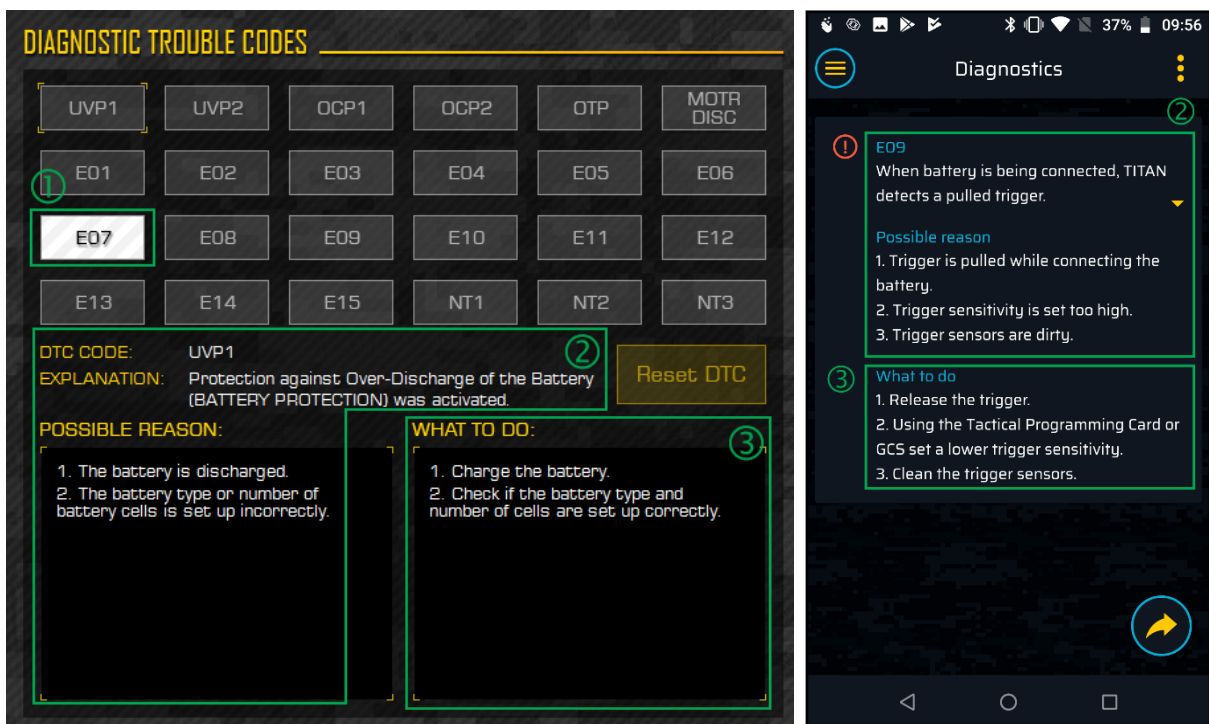

If an error occurs, it will be ① highlighted and ② described. In such a case, we suggest to follow ③ “WHAT TO DO” instructions in the first place.

## 6. TITAN V2

TITAN V2™ is an AEG Control System for V2 gearboxes which will transform your AEG into an advanced training weapon. Adjust your AEG and check the Statistics using USB-Link and GATE Control Station app for PC/MAC and Android devices. Gain a tactical advantage thanks to the extremely fast trigger response, option of adjusting trigger sensitivity to your preferences and many other useful functions. Give your AEG a new lease of life!

Thanks to the optical sensors we have eliminated the problem of faulty switches that can occur in competitors' drop-in mosfets. The trigger has no mechanical connections with the PCB. This eliminates mechanical stresses and provides for high reliability.

TITAN V2 has the following sensors:

- 1 sector gear sensor
- 2 fire selector sensors
- 5 trigger sensors

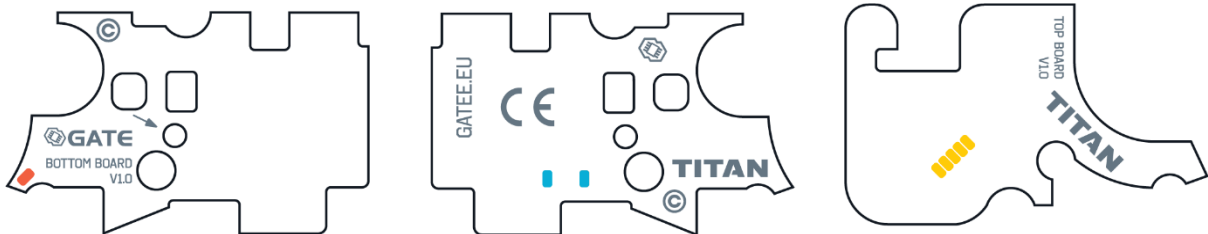

SETS COMPARISON		TITAN v2	
SET INCLUDES	ADVANCED SET	BASIC MODULE	
TITAN with ADVANCED firmware edition	✓	✗	
TITAN with BASIC firmware edition	✗	✓	
USB-Link	✓	✗	
USB-A cable for USB-Link	✓	✗	
USB-C cable for USB-Link	✓	✗	
Micro-USB cable for USB-Link	✓	✗	
Tactical Programming Card	✗	✗	

## 6.1. TITAN V2 Advanced Set

At once you purchase TITAN with ADVANCED firmware edition, USB-Link and USB cables allowing to connect TITAN to PC/MAC as well as Android device.

The ADVANCED firmware edition offers wide variety of functions and is dedicated for those who like complex solutions. It enables access to the Statistics and TITAN World Rankings. To learn all the differences between firmware editions, please check the comparison table.



### Advanced Set contents:

1. TITAN V2 with ADVANCED firmware edition (rear or front wired)
2. USB-Link for GATE Control Station™ App
3. USB-A Cable for USB-Link [1.5m / 4ft 11in]
4. USB-C Cable for USB-Link [0.6m / 1ft 11in]
5. Micro-USB Cable for USB-Link [0.6m / 1ft 11in]
6. Installation Kit
7. Quickstart Guides

## 6.2. TITAN V2 Basic Module

The best if you long for having TITAN in two or more airsoft guns. Then you do not need the second USB-Link from the Advanced or Complete set. It includes TITAN with BASIC firmware edition.

The BASIC firmware edition is an economic version with limited number of functions, dedicated for those who prefer simplicity but require highest quality. If you decide to have more functions, there is always option to upgrade firmware from BASIC to ADVANCED.

Basic Module is also suitable for you if you decide to purchase the USB-Link separately.



### Basic Module contents:

1. TITAN V2 with BASIC firmware edition (rear or front wired)
2. Installation Kit
3. Quickstart Guide



### Notice

In order to configure TITAN, you need the USB-Link or Tactical Programming Card which is not included in this kit.



### 6.3. Installation safety



#### Caution

A sector gear can damage a gear sensor during installation. Stay careful to avoid this damage.

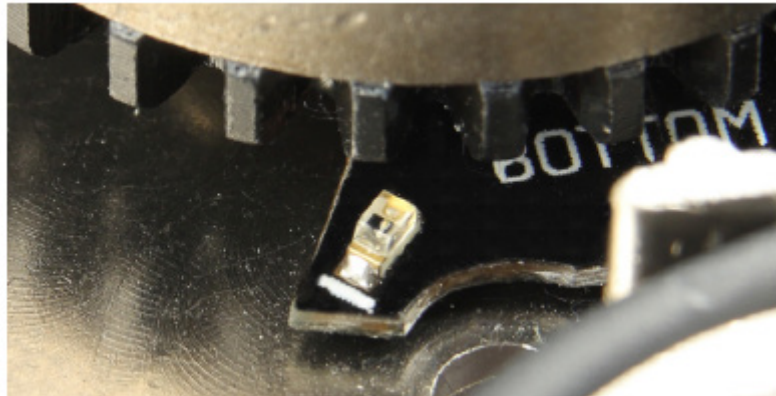

#### Caution

Gearbox shell manufactured by ICS and Krytac must be modified to achieve 100% compatibility with TITAN V2. Lack of the modification will permanently damage your unit, which is not covered by the warranty.

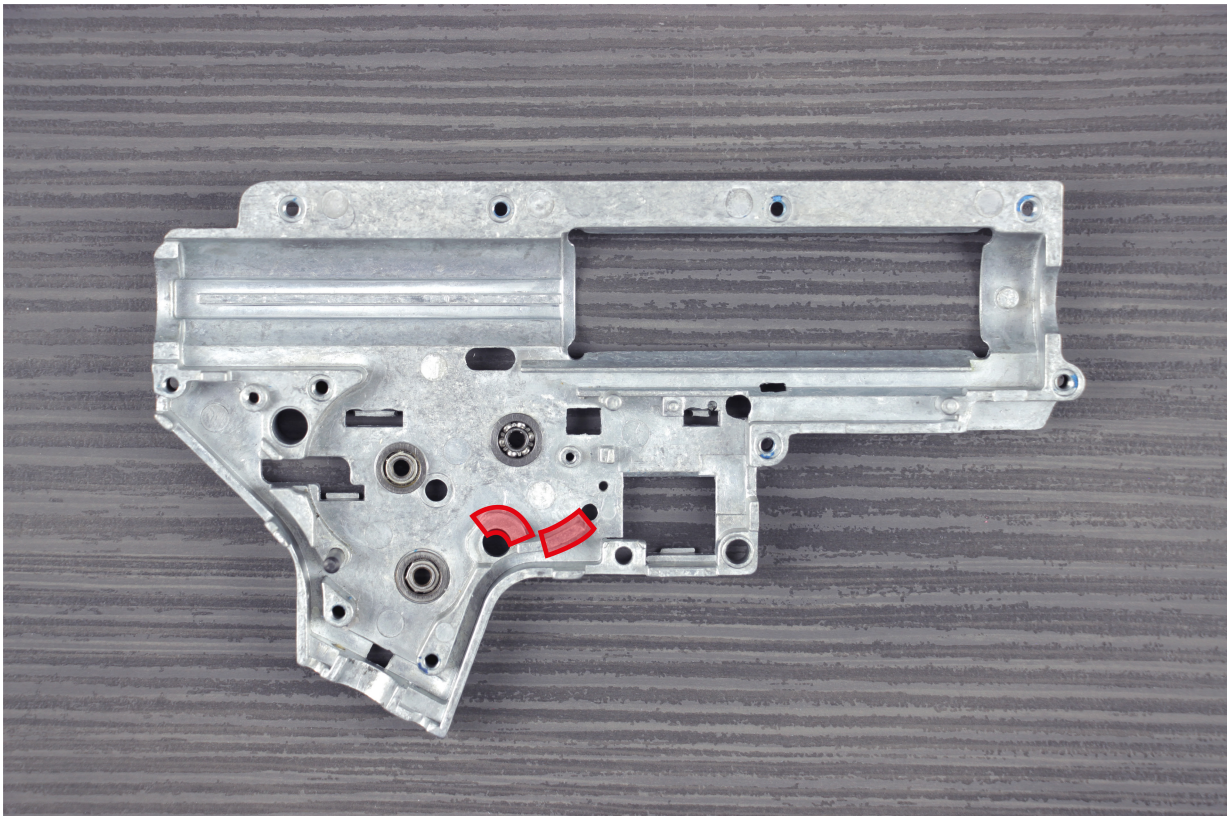

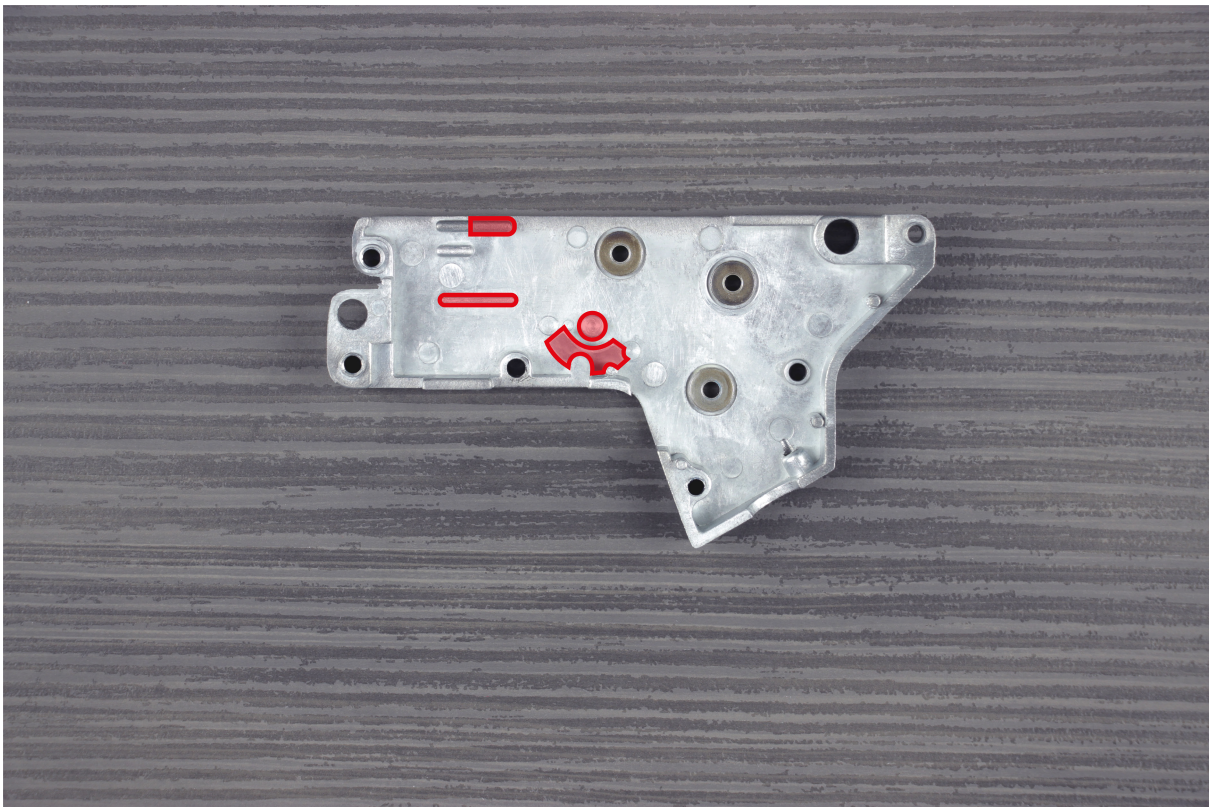
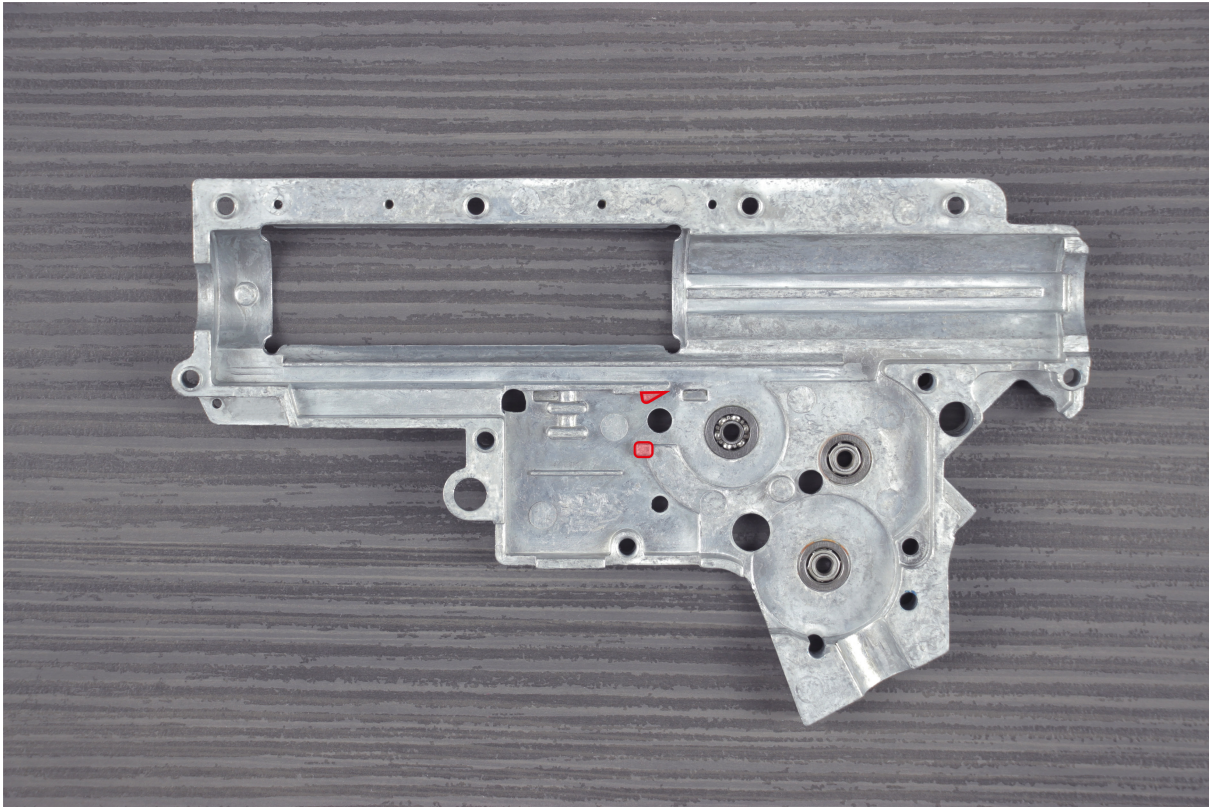

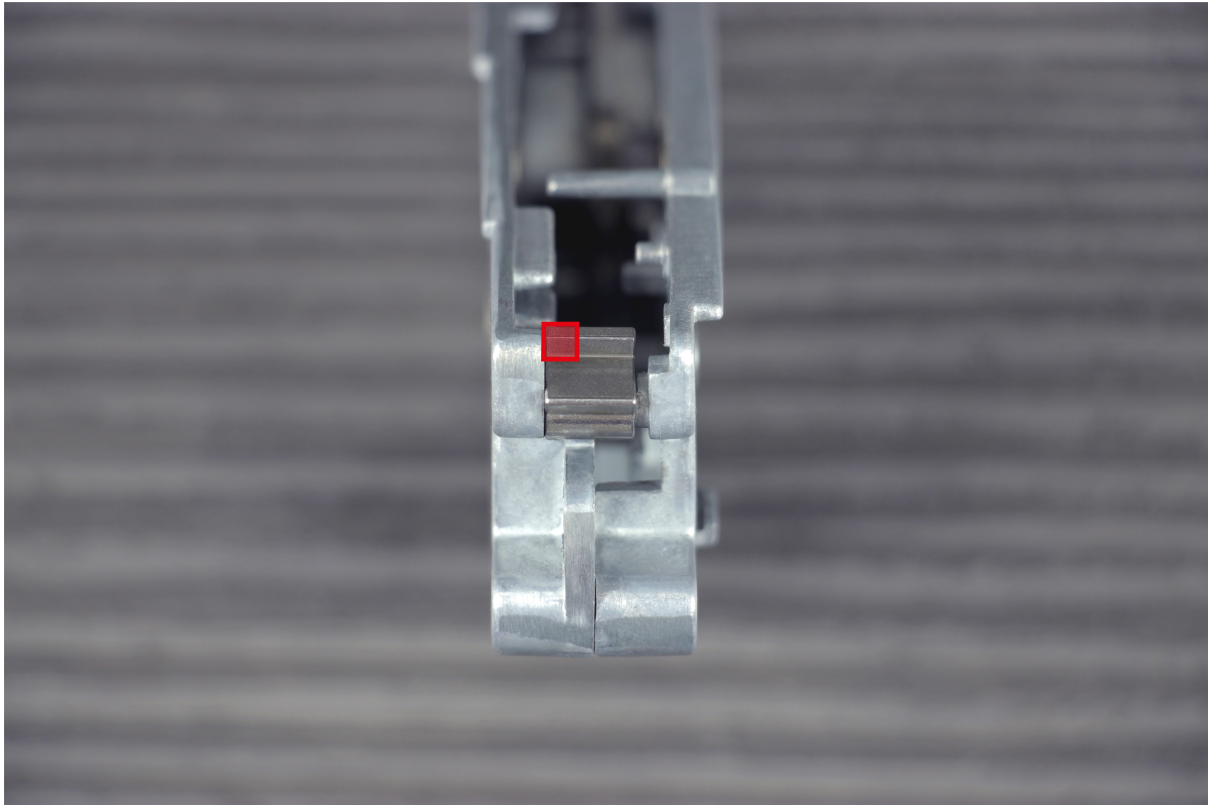

**Caution**

Placing the washers in wrong order will cause short circuit and permanent damage to the TITAN, which is not covered by the warranty.

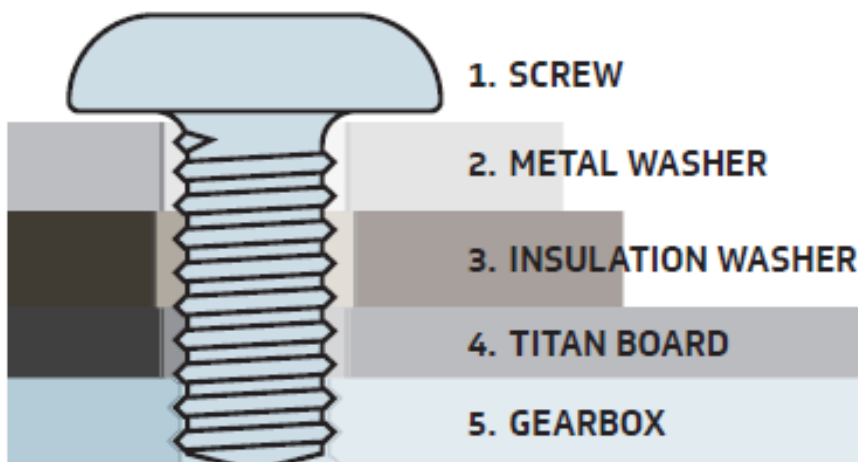
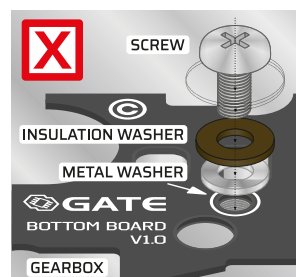
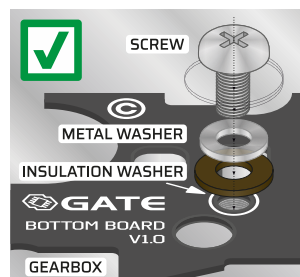



### Caution

The improper placement of wiring under motor gear can cause insulation damage and a short circuit.

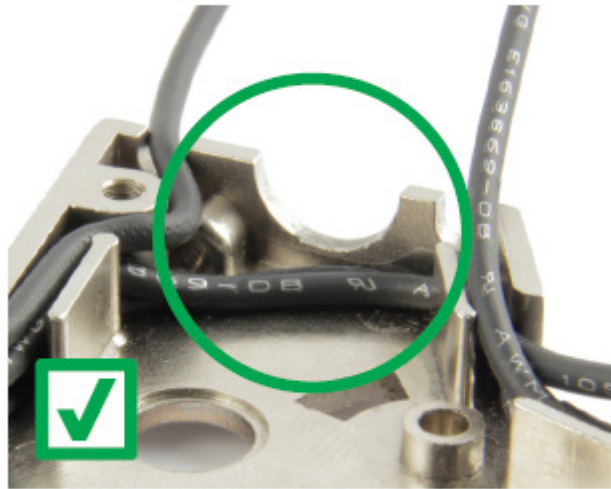

### Caution

Do not pull the trigger when gearbox is open. It may result in trigger sensors' damage.



### Notice

In case of some triggers (e.g. speed or CNC triggers), first trigger sensors might be covered even if the trigger is not pulled.

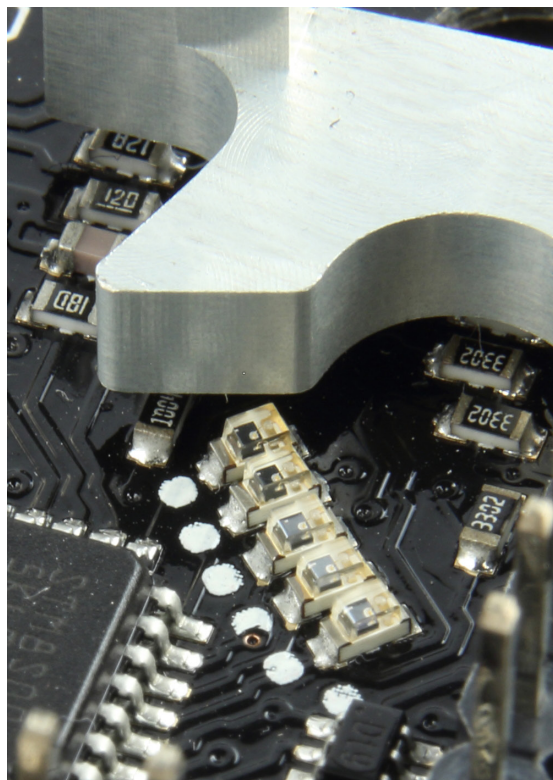





### Notice

A selector sensor does not detect black surface. If your selector does not have metal connector, you must use sticker from the kit.

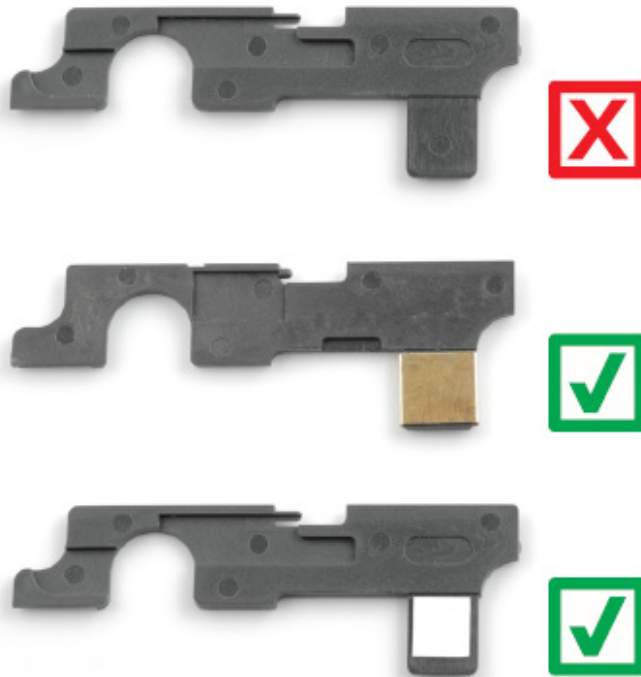

### Notice

The sticker position is very important. Pay attention to place the sticker very close to the left edge, between the top and bottom red lines.

The set contains 3 different sticker types. At first, use the sticker with narrower black line. If you are not able to calibrate selector well, you should try other stickers.

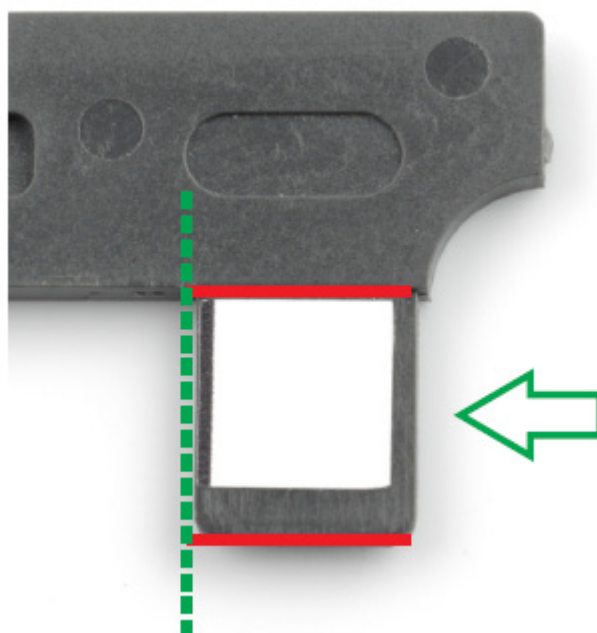

## 6.4. Installation

### Installation Kit contents:

1. Selector plate stickers
2. Female deans-t connector
3. Motor connectors 2.8 x 0.5 mm [0.11 x 0.02 in]
4. 0.7mm [0.03 in] screw and washers set
5. 0.5mm [0.02 in] screw and washers set



### You will need:

- cross-head screwdriver
- flat-blade screwdriver
- metal file or milling machine
- solvent
- grease
- USB-Link, micro USB-Cable and PC / MAC or OTG cable and Android device

### Follow the steps below in order to mount the TITAN drop-in module:

1. Remove the gearbox from the AEG body.
2. Disassemble your gearbox, take out all the internals.
3. Clean the gearbox case using solvent.

4. Pay attention to the marked area. If you see that it is not smooth, use a metal file or grindstone to prepare the surface. The gearbox surface should be smooth, with no sharp edges which would damage the TITAN.

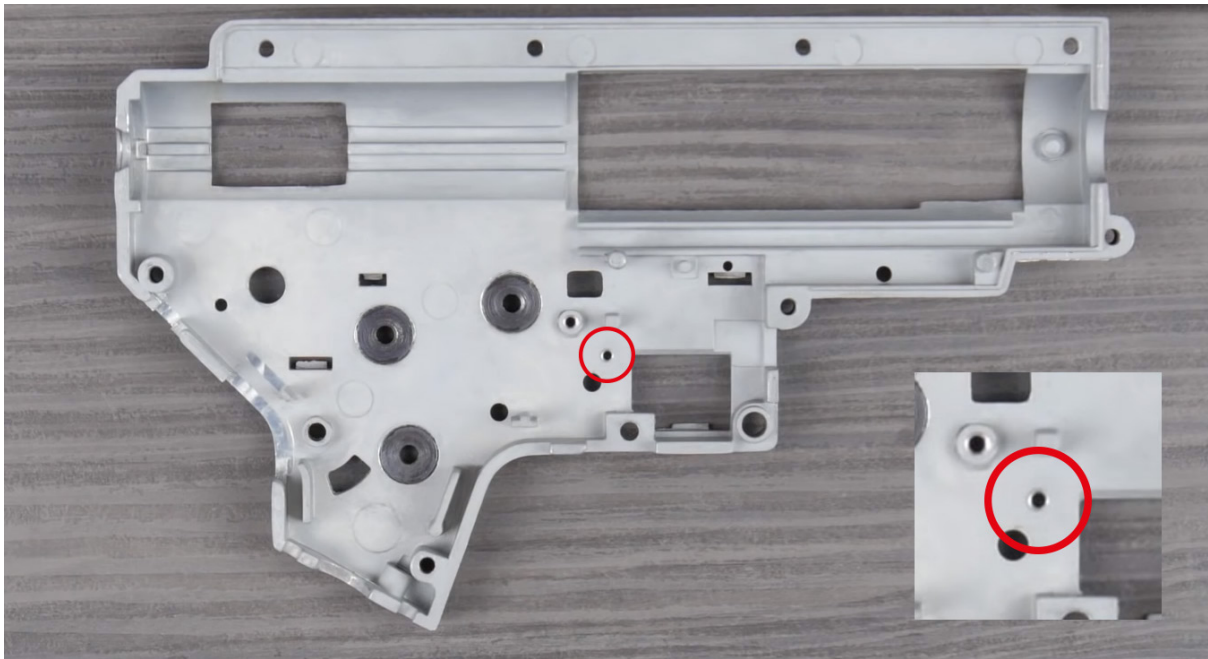

5. Detach the drop-in module carefully.



- Place the bottom board on the bottom part of the gearbox. Do not use a screw yet. Check if the bottom board is laid flat in the gearbox.

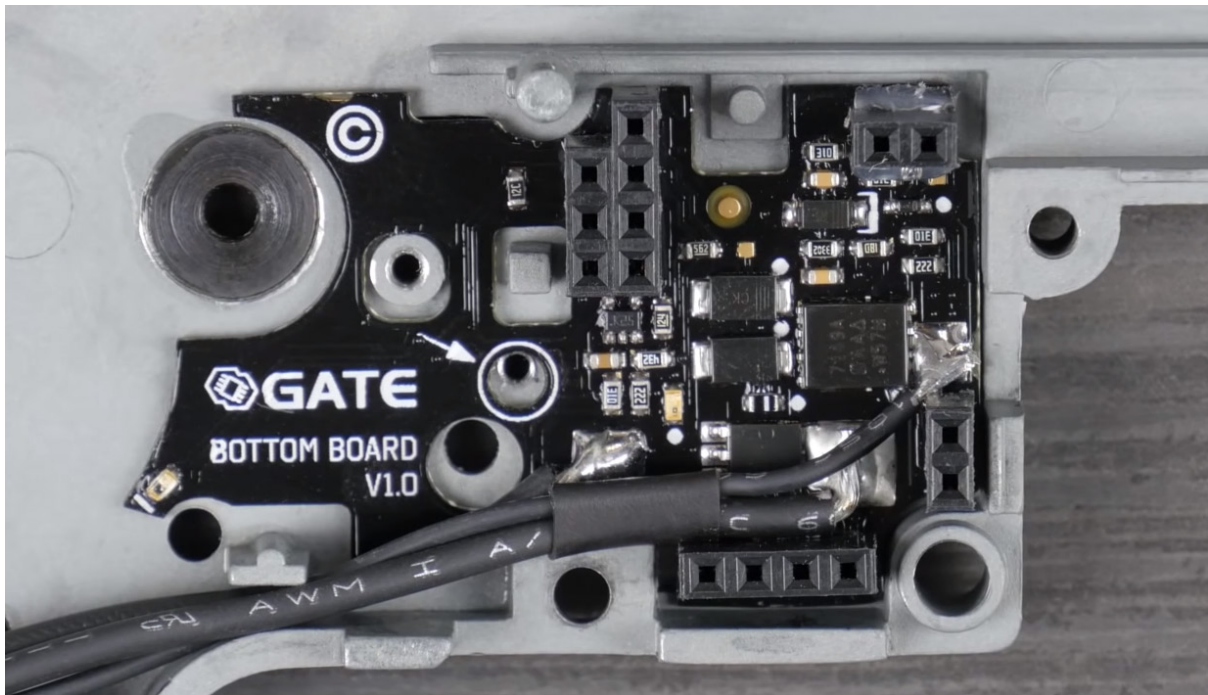

- Make sure the electronic components do not touch the gearbox case.

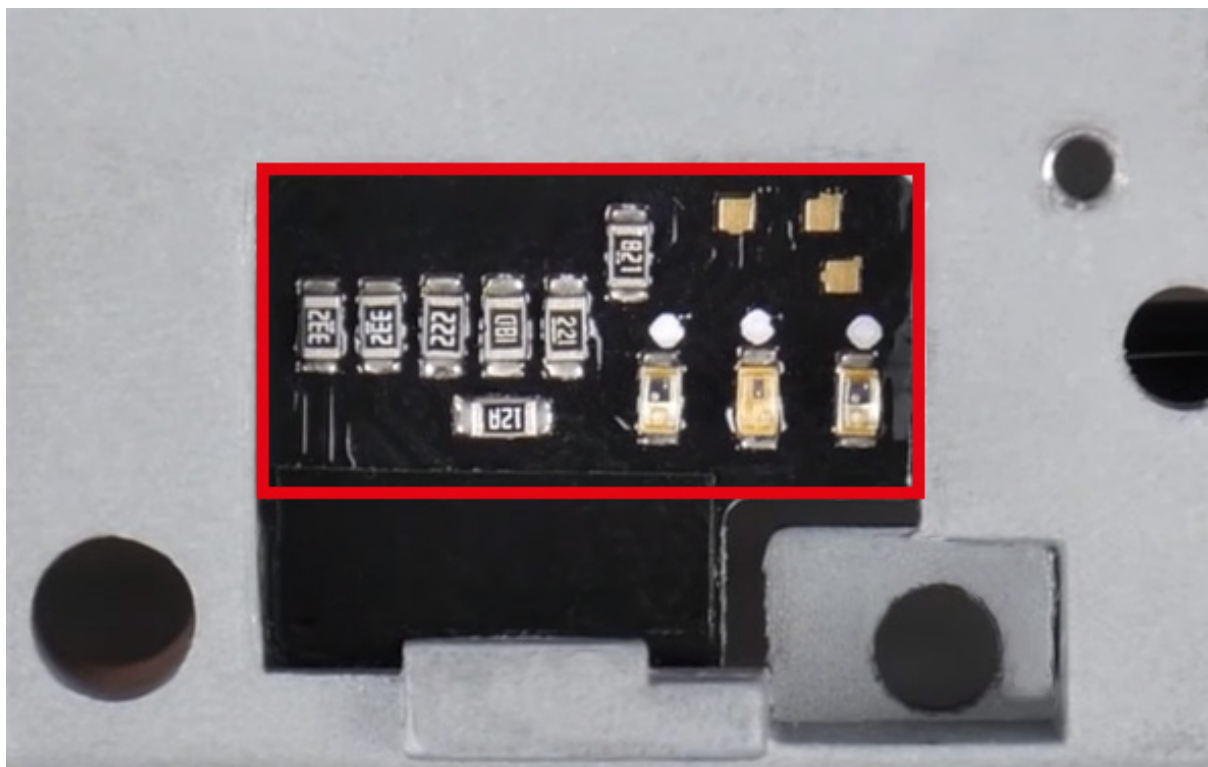

8. Use the insulation (black) washer from the kit. ATTENTION! The insulation washer must protect the circuit board. The metal screw and metal washer cannot touch the board directly. It can result in a short circuit and TITAN damage which is not covered by the warranty.

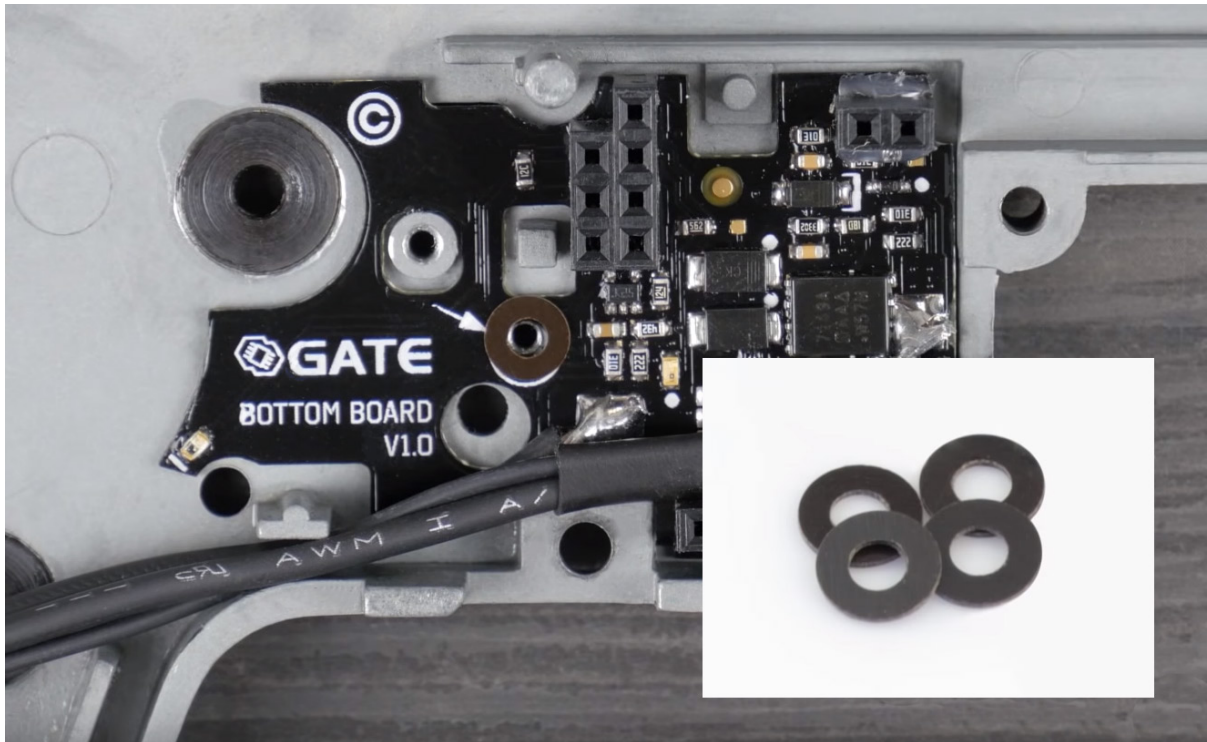

9. Screw on the bottom board to the case. Use the original screw or the one from the TITAN kit.

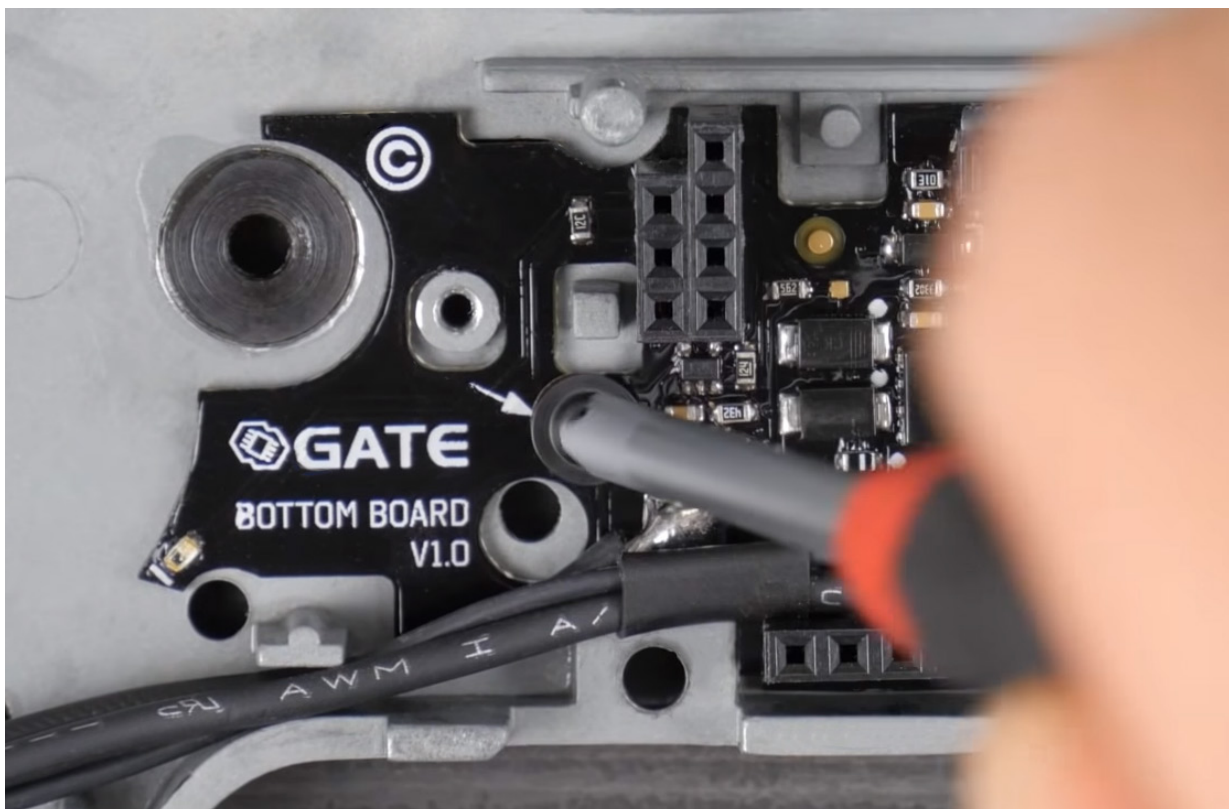

10. Check if the screw sticks out of the gearbox.

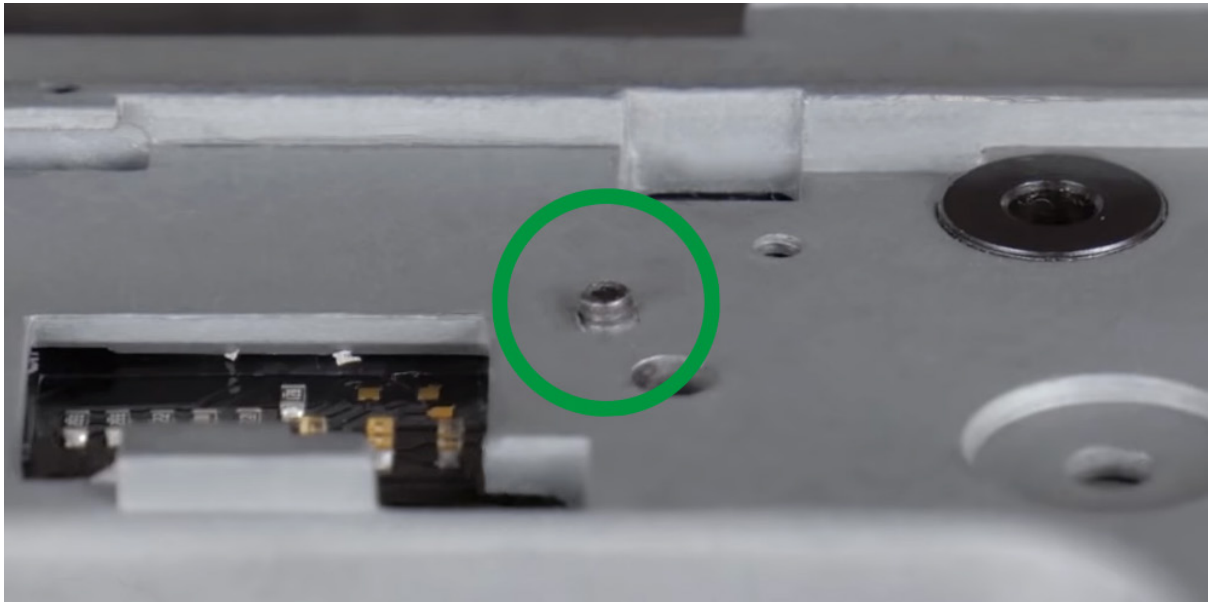

11. If so, add metal washer(s) included in the kit. Make sure that the metal washer is placed between the screw and the insulation washer. It cannot touch the circuit board directly.

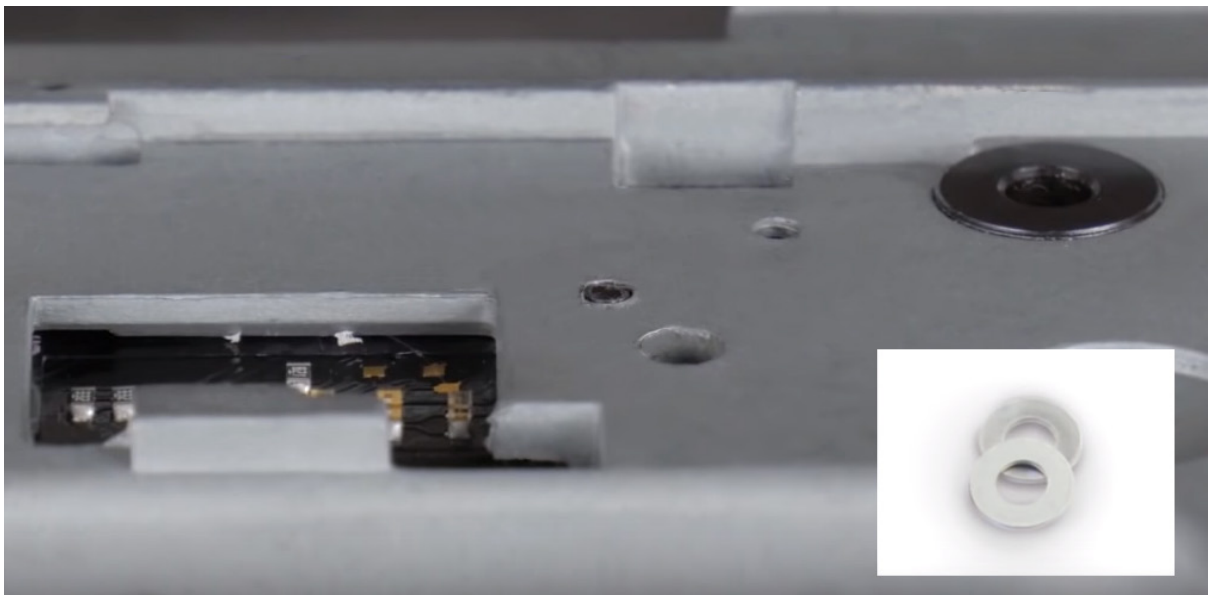

12. Check if the top board fits gearbox without any problems.

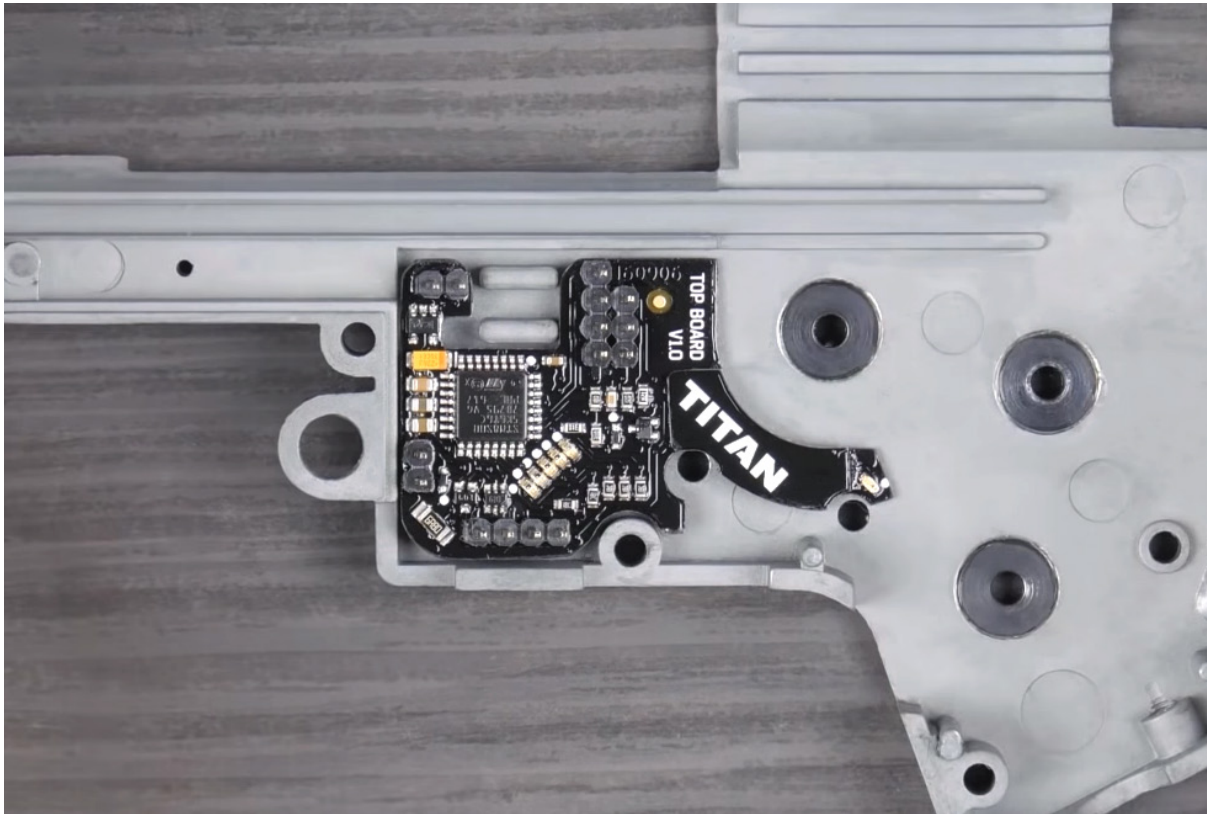

13. Loosen the screw. Adjust the position of the bottom board. The distance between the board and the bearing should be similar as indicated in the marked area.

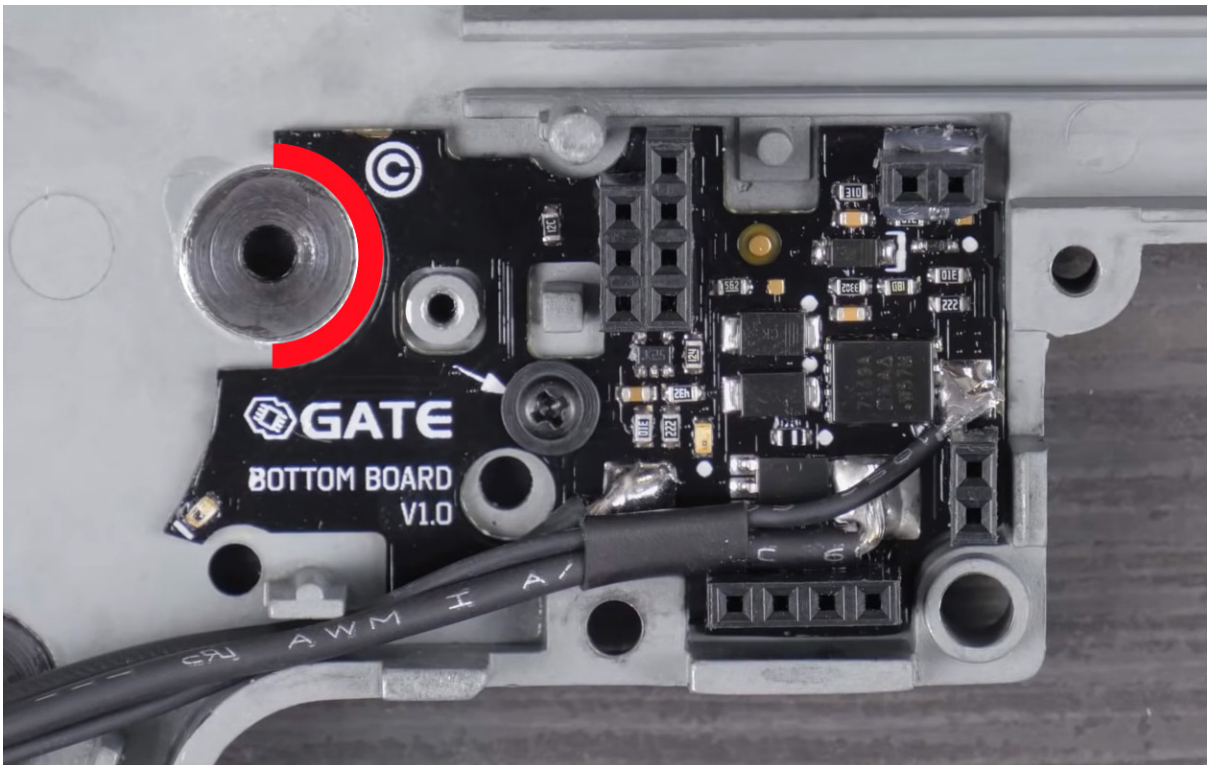



**Notice**

Sector gear sensor placement is very important.

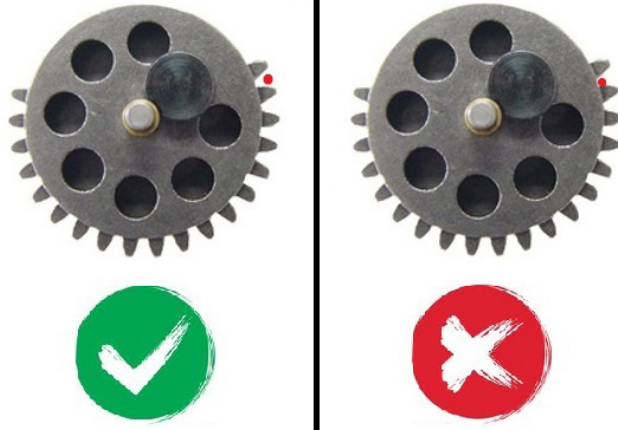

14. Make sure the marked areas are not covered by board or wires.

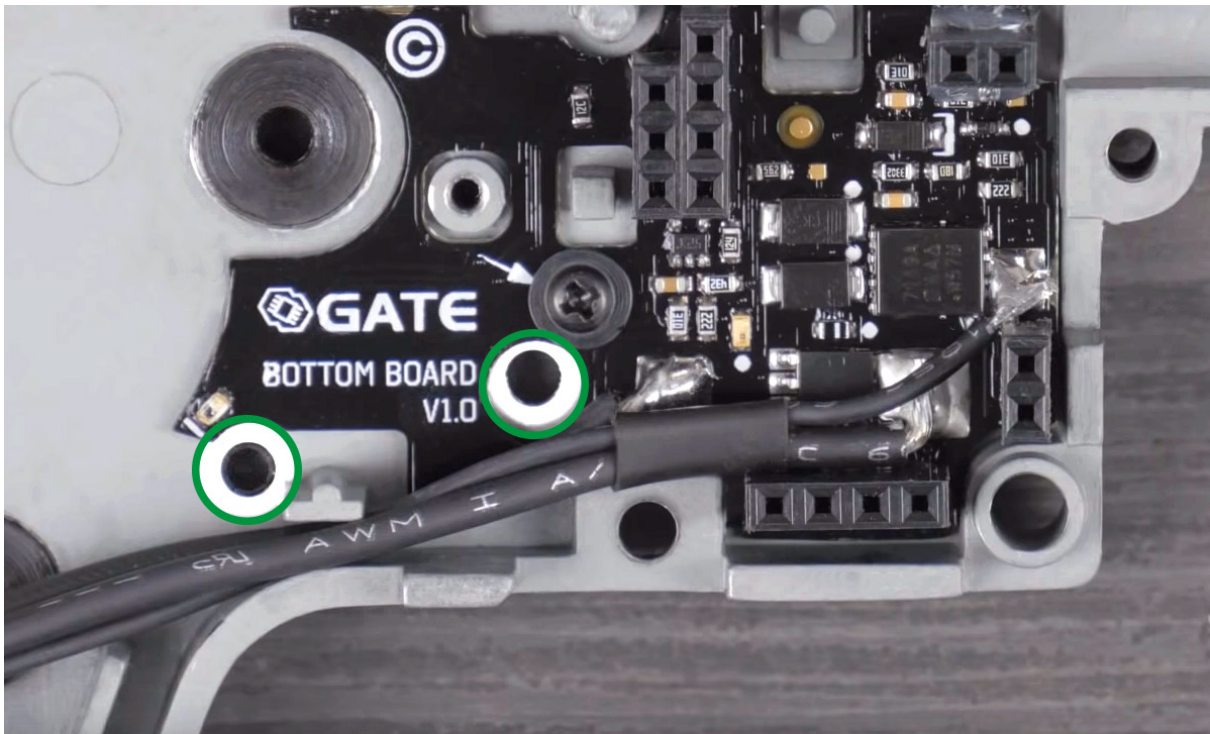



15. Check if sensors are clean and not covered by wires.

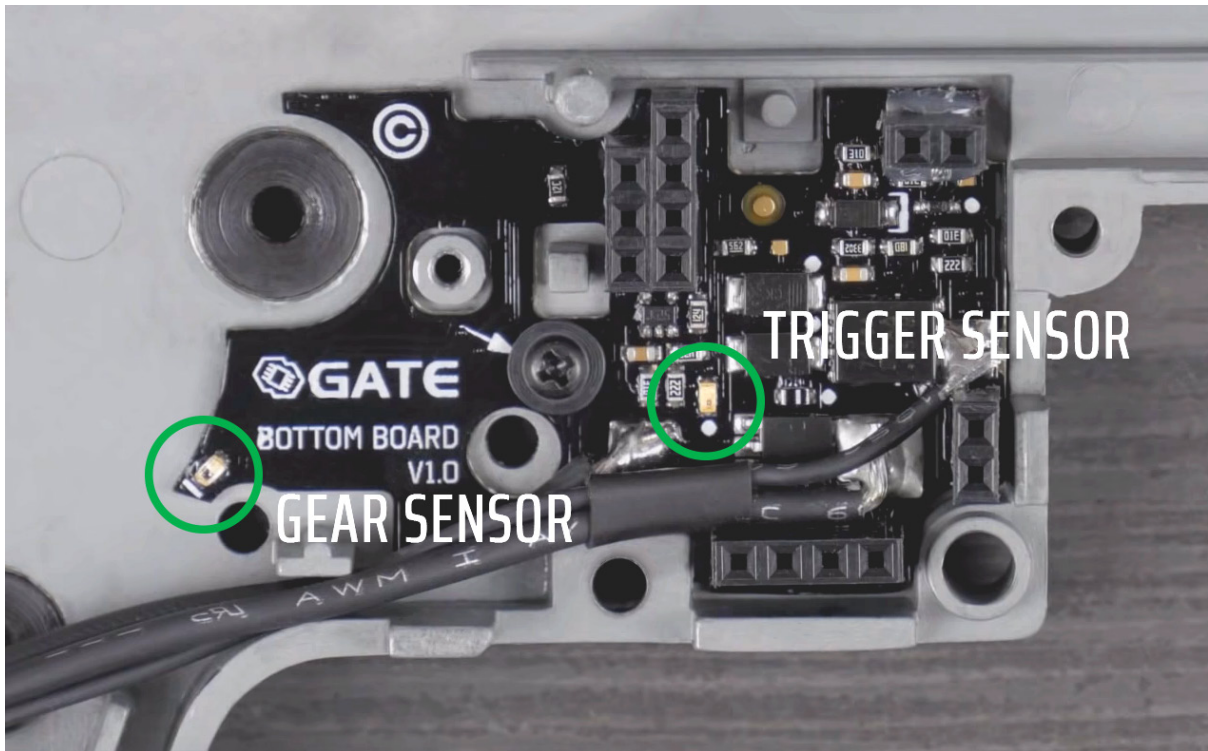

16. Some gearboxes need modification. Check if your gearbox has the marked pins. If so, remove them.

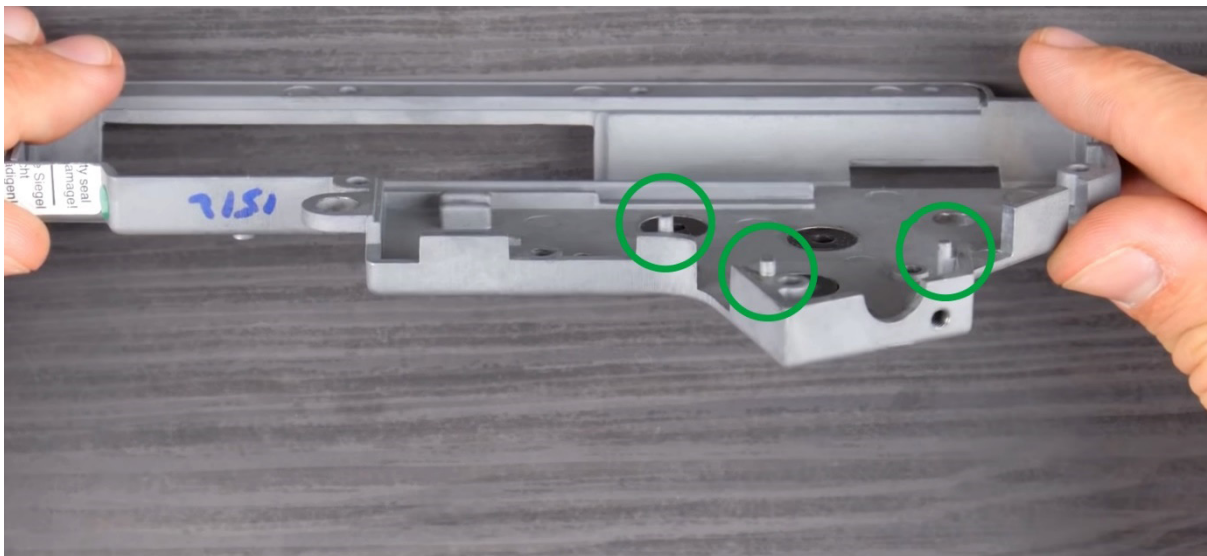

17. Check if both parts of the gearbox fit together perfectly.

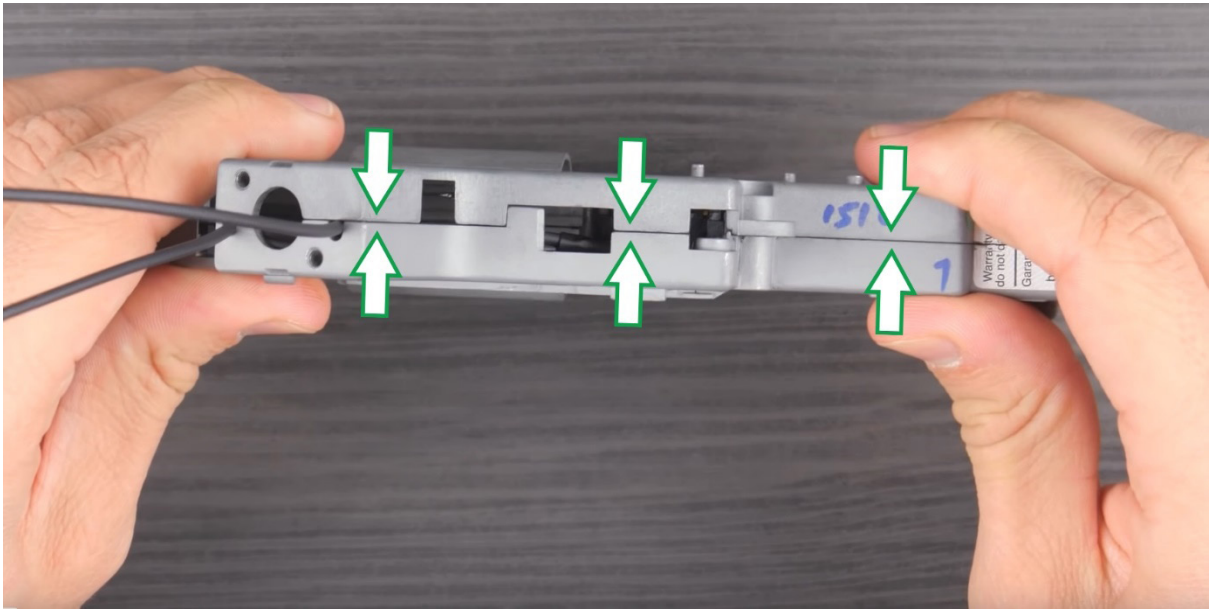

18. Mount the trigger without spring. Insert the TITAN top board. Close the gearbox. **When the gearbox is closed**, carefully check if the trigger moves smoothly and does not touch any TITAN's components.



19. Mount the sector gear, trigger with spring and top TITAN board. Make sure that the gear does not touch TITAN.

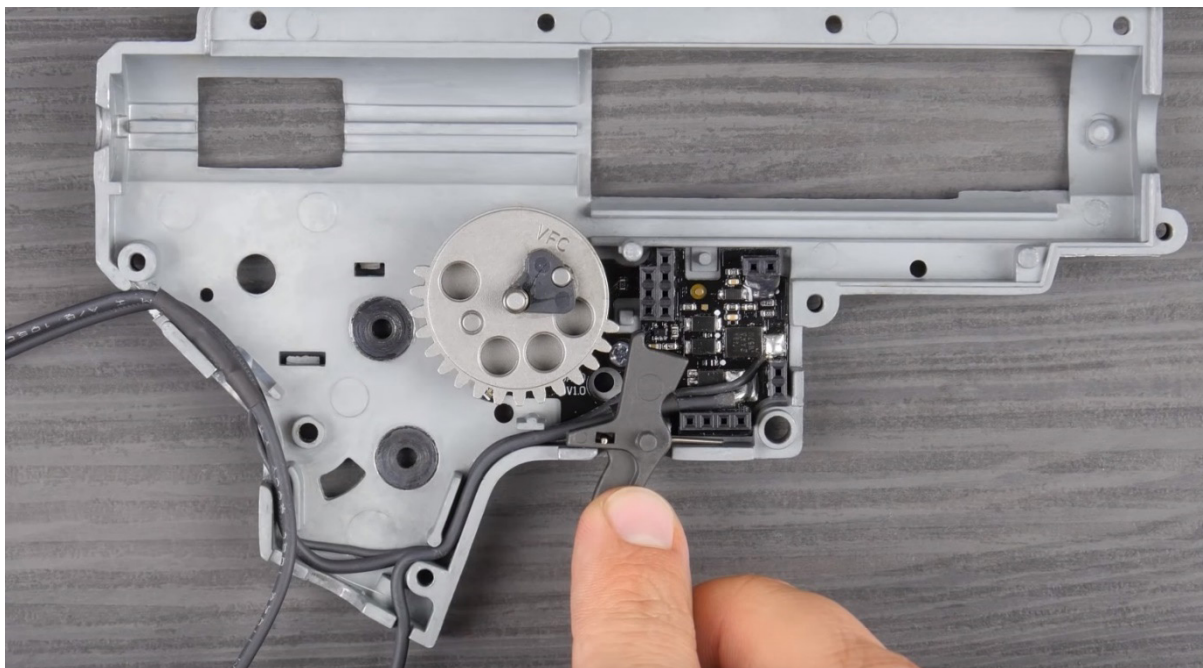

20. Close the gearbox. Tighten two screws on the top part of the gearbox case.



21. Prepare selector plate. If the selector plate does not have copper connector, you need to modify it. The black surface does not reflect light, so sensors cannot work properly.

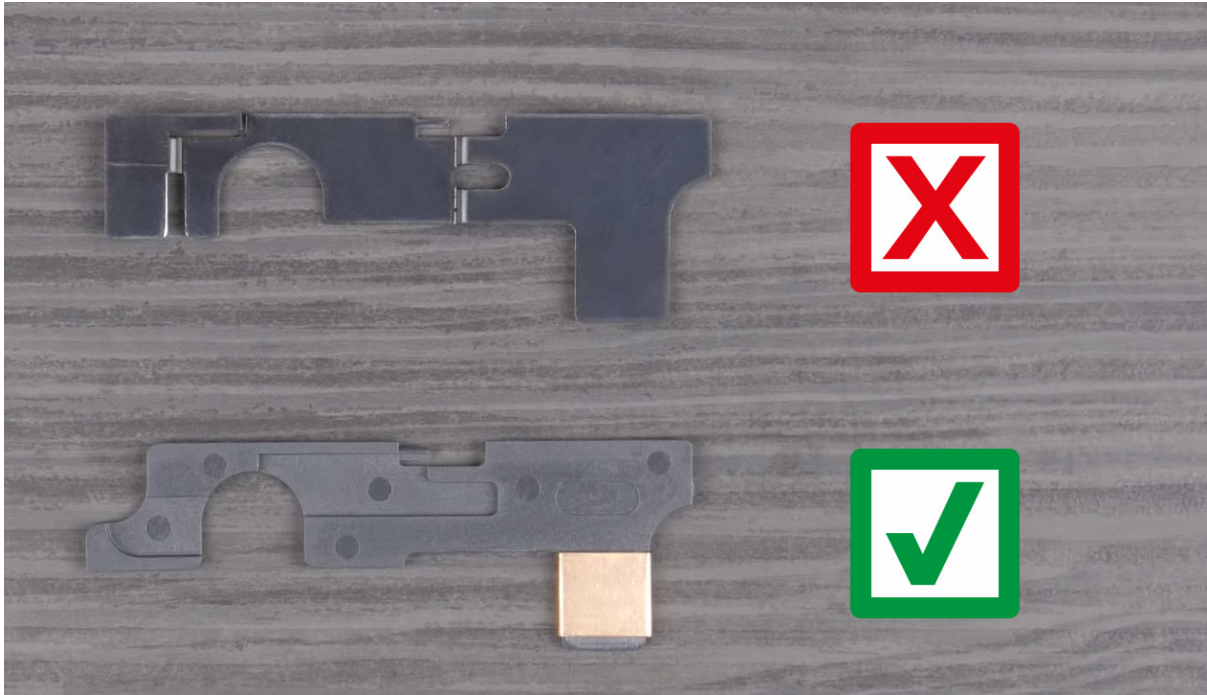

22. In order to modify the black plate, use a sticker from the installation kit. At first, try to use the 'middle' sticker.



**Notice**

If the selector plate has copper connector, **do not make any modifications.**

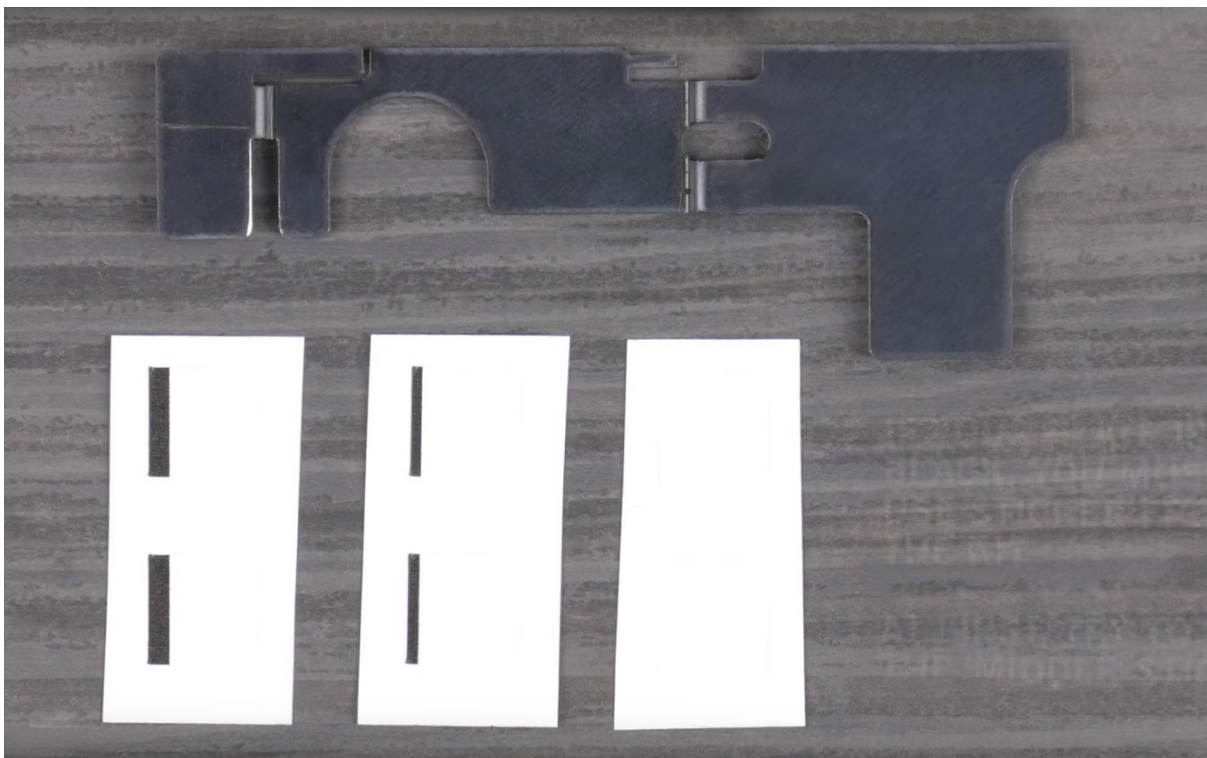

23. Black plate after modification. The sticker location is very important. It should be as close to the left side as possible.



24. Install the selector plate.

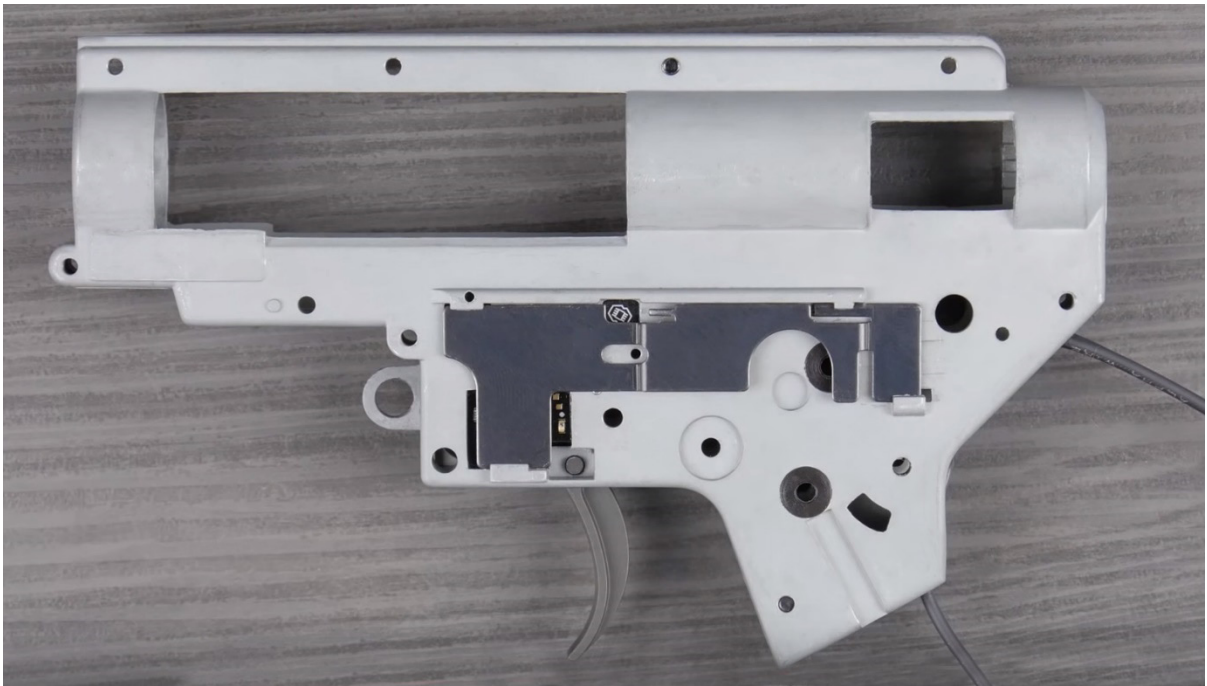

25. Connect TITAN to your PC using USB-Link. Start the GATE Control Station App.

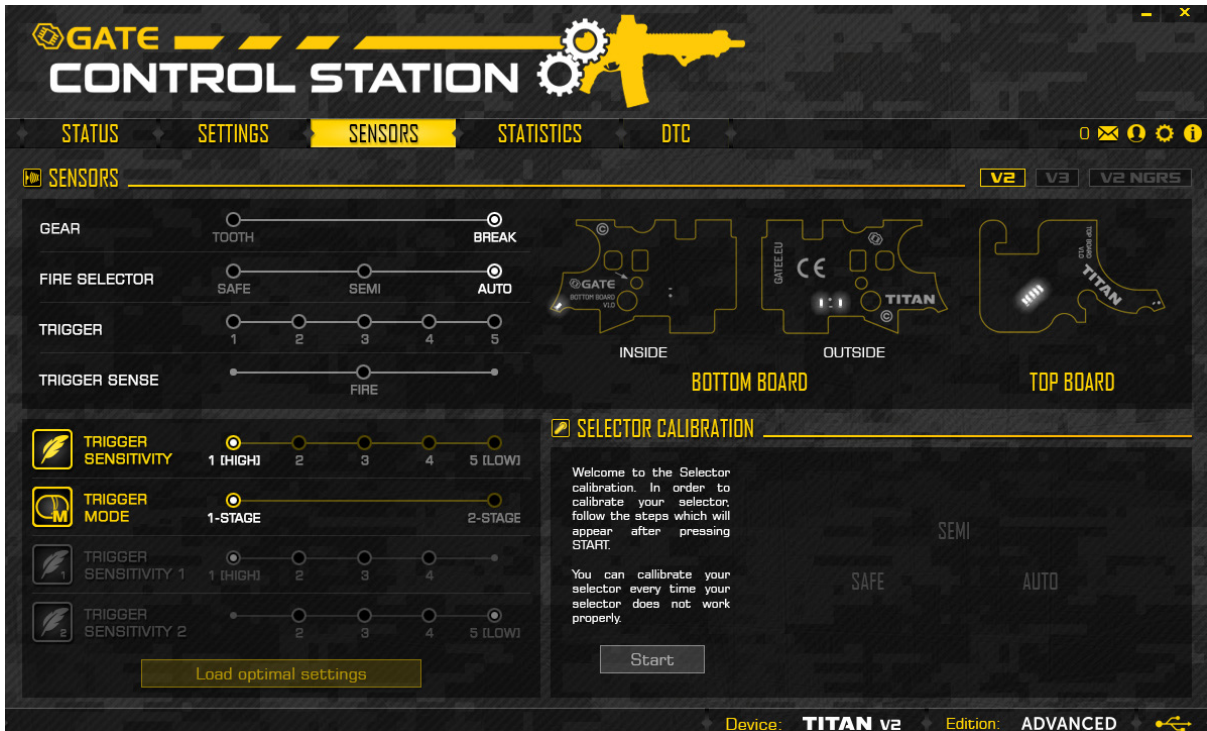

26. Pull the trigger slowly. The TRIGGER SENSORS LED indicators will stop glowing, one by one. They indicate active sensors. In case of some trigger models, first sensors might be active even when the trigger is not pulled.

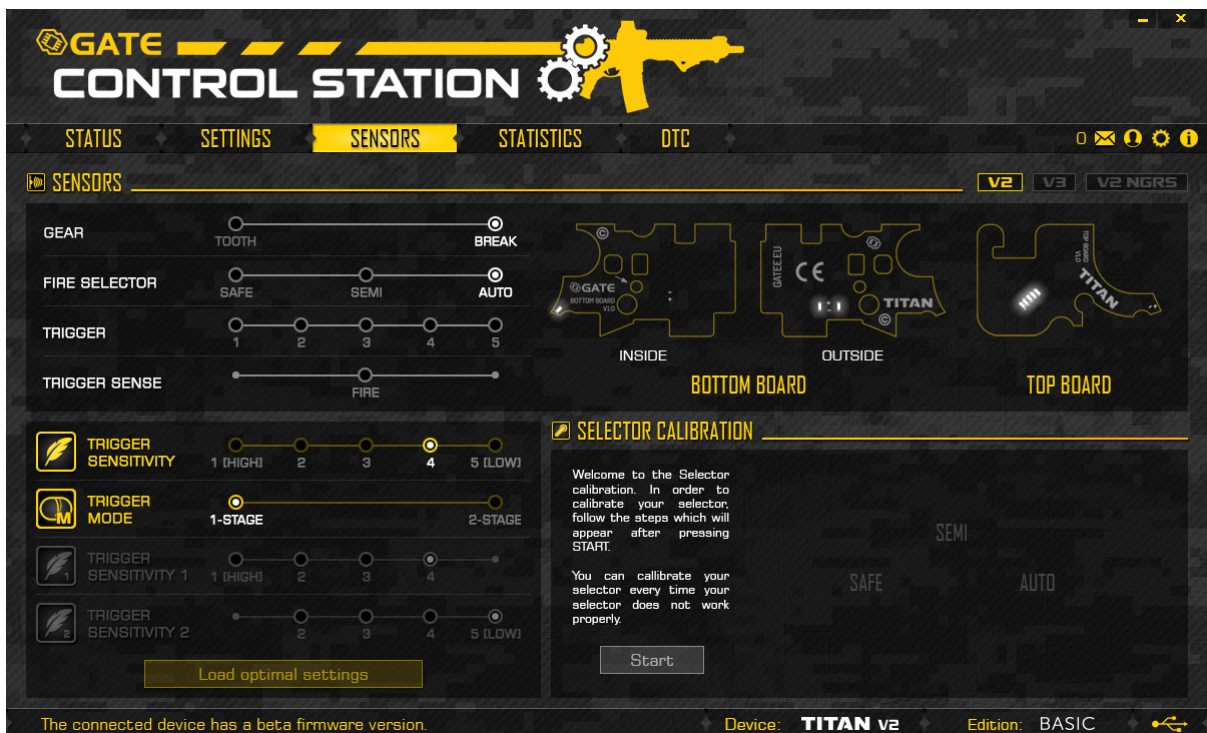

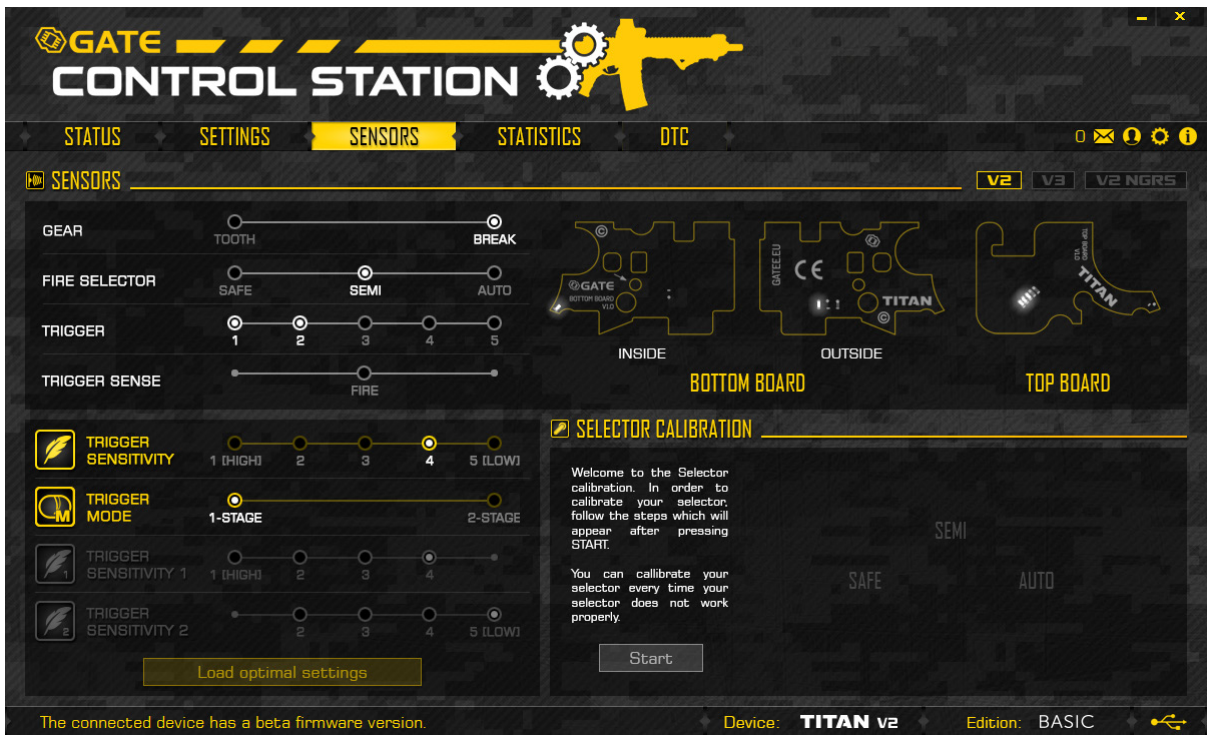

27. Check if the sensors recognize the selector plate. Moving the selector plate, verify if TITAN detects SAFE, SEMI and AUTO.

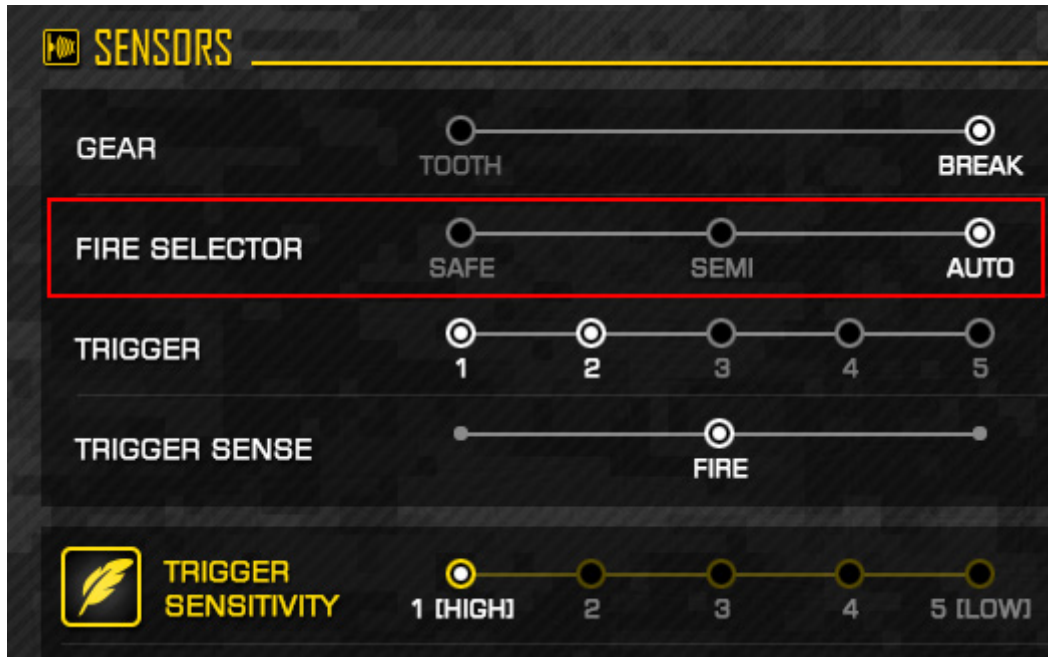

28. If all the three LED indicators are ON, this means an error.





**i Notice**  
This error occurs mostly when a selector plate does not reflect light. It can also occur if too much light reaches sensors. Then you need to cover the sensors.

29. Turn the gear slowly to check if the sensor detects teeth. Keep in mind that the TITAN reads the sensors much quicker than the GCS.

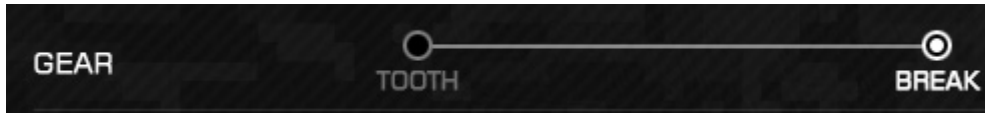

30. Insert gearbox into body and check whether the TITAN detects the fire selector position correctly.



Switch should take place approximately halfway between selector positions:

- a) SAFE - SEMI ~45°
- b) SEMI - AUTO ~135°

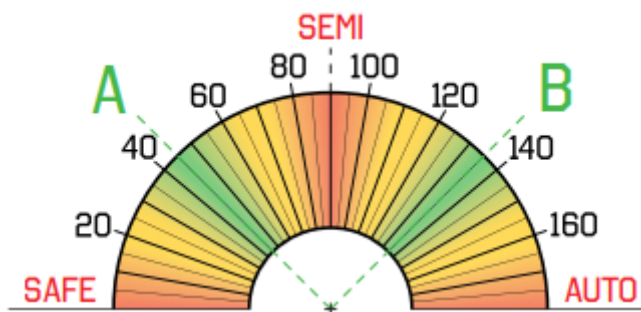

Otherwise, you need to modify the selector plate with other sticker.

31. If all the sensors work flawlessly, you can assemble the gearbox. Do not use too much grease. In a critical situation, excessive grease may cover a sensor.

**i Notice**

A few initial shots are 'calibration shots'. TITAN adapts to the gearbox configuration. In order to readapt TITAN, you must restore factory settings or change gear ratio. This is necessary e. g. if you replaced motor

## 7. TITAN V3

TITAN V3™ is an AEG Control System for V3 gearboxes which will transform your airsoft gun into an advanced training weapon. Adjust your AEG and check the Statistics using USB-Link and GATE Control Station app for PC/MAC and Android devices. TITAN V3 enables you to adjust the trigger sensitivity with military precision. The innovative proximity trigger sensor offers you even 250 possible sensitivity settings. Gain a tactical advantage thanks to the extremely fast trigger response and many other useful functions. Give your AEG a new lease of life!

TITAN V3 has the following optical sensors:

- 1 sector gear sensor
- 1 fire selector sensor
- 1 proximity trigger sensor

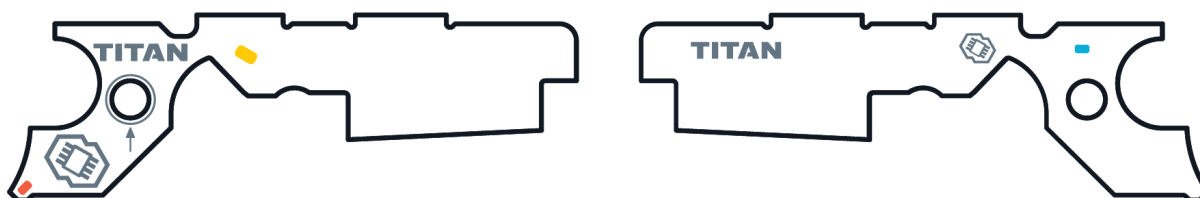

SETS COMPARISON		TITAN v3	
SET INCLUDES	ADVANCED SET	BASIC MODULE	
TITAN with ADVANCED firmware edition	✓	✗	
TITAN with BASIC firmware edition	✗	✓	
USB-Link	✓	✗	
USB-A cable for USB-Link	✓	✗	
USB-C cable for USB-Link	✓	✗	
Micro-USB cable for USB-Link	✓	✗	
Tactical Programming Card	✗	✗	

## 7.1. TITAN Advanced Set

At once you purchase all you need to take total advantage from TITAN. It includes TITAN with ADVANCED firmware edition.

The ADVANCED firmware edition offers wide variety of functions and is dedicated for those who like complex solutions. It enables access to the Statistics and TITAN World Rankings. To learn all the differences between firmware editions, please check the comparison table.



### Advanced Set contents:

1. TITAN V3 with ADVANCED firmware edition
2. USB-Link for GATE Control Station™ App
3. USB-A Cable for USB-Link [1.5m / 4ft 11in]
4. USB-C Cable for USB-Link [0.6m / 1ft 11in]
5. Micro-USB Cable for USB-Link [0.6m / 1ft 11in]
6. Installation Kit
7. Quickstart Guides

## 7.2. TITAN Basic Module

The best if you long for having TITAN in two or more airsoft guns. Then you do not need the second USB-Link from the Advanced set. It includes TITAN with BASIC firmware edition.

The BASIC firmware edition is an economic version with limited number of functions, dedicated for those who prefer simplicity but require highest quality. If you decide to have more functions, there is always option to upgrade firmware from BASIC to ADVANCED.

Basic Module is also suitable for you if you decide to purchase the USB-Link separately.



## Basic Module contents:

1. TITAN V3 with BASIC firmware edition
2. Installation Kit
3. Quickstart Guide

### Caution

TITAN V3 is compatible with most standard V3 gearboxes. Please note that ARES and UMAREX gearbox shells as well as Tokyo Marui Next Generation gearboxes are not compatible with TITAN V3. If you are not sure whether your gearbox is compatible, please contact us at [titan@gatee.eu](mailto:titan@gatee.eu)

### Notice

TITAN V3 is not compatible with Tactical Programming Card.

## 7.3. Installation safety

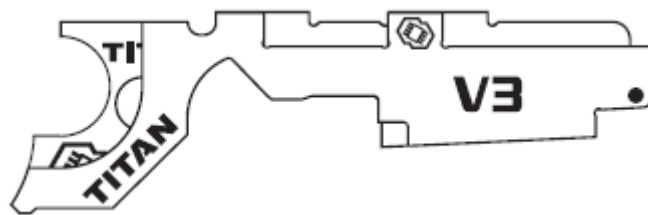

### Notice

The TITAN V3 fits CNC gearboxes with very small backlash. While fitting the TITAN, pull the cables and at the same time push the board into the right place. Pay attention to the area marked in yellow to fit the board correctly.

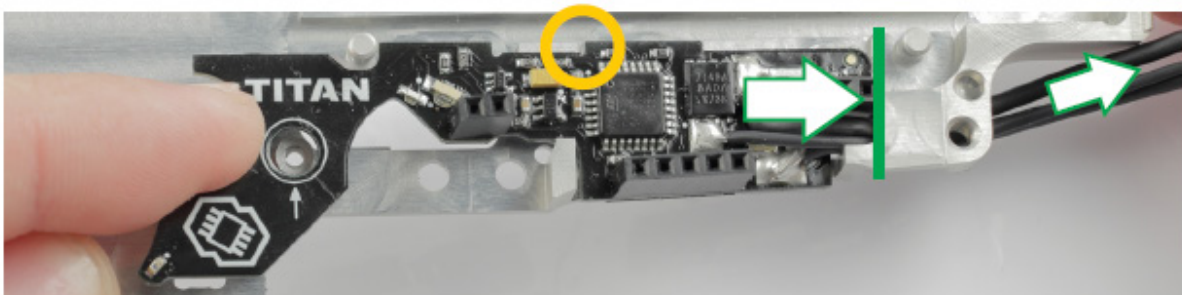



**Notice**

Use the trigger sticker to make it visible for trigger sensor.

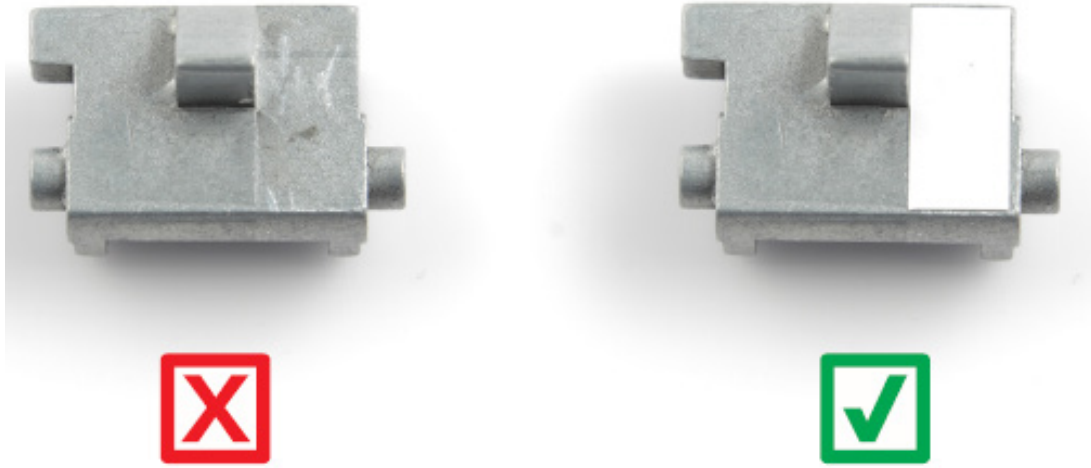

**Notice**

TITAN detects trigger position very precisely. In order to use it, you need to eliminate trigger backlash. The set contains 3 trigger anti-backlash stickers of different thickness. Try each of them and choose the most proper one.

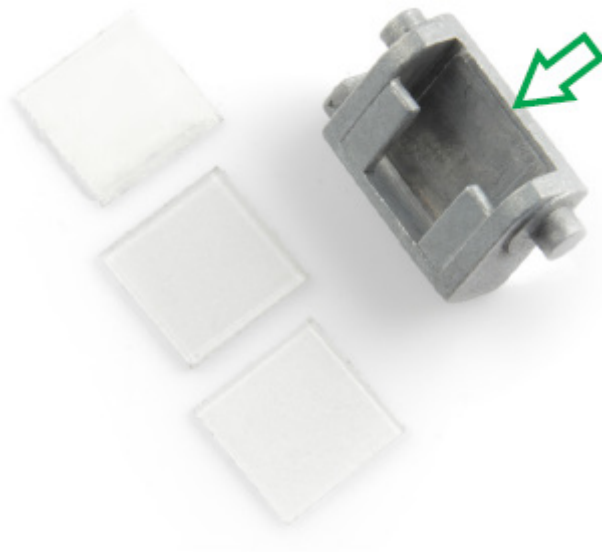



### Notice

The selector plate requires modification. Place the selector sticker according to the photos below.



### Notice

The sticker position is very important.

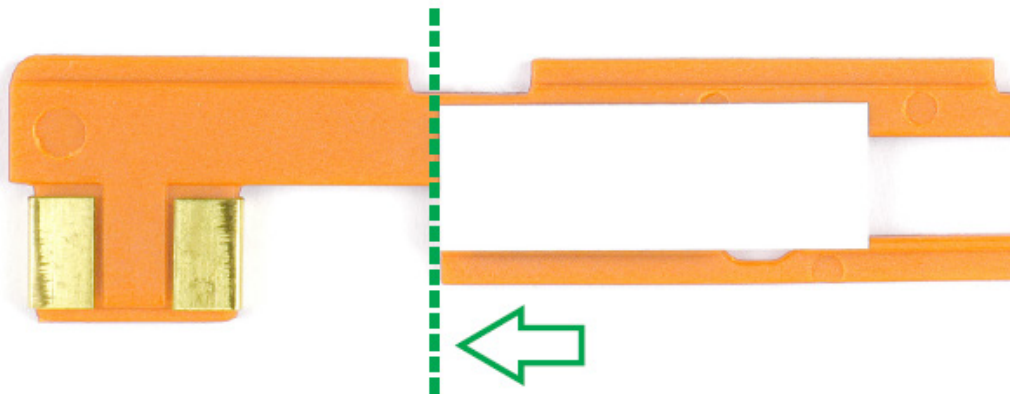

## 7.4. Installation

### Installation kit contents:

1. Selector plate stickers (3 pcs)
2. Trigger stickers (6 pcs)
3. Connectors set
4. 0.15mm [0.006 in] trigger anti-backlash stickers (3 pcs)
5. 0.3mm [0.012 in] trigger anti-backlash stickers (3 pcs)
6. 0.5mm [0.02 in] trigger anti-backlash stickers (3 pcs)
7. 0.3mm [0.012 in] washers set
8. 0.2mm [0.008 in] washers set
9. 0.1mm [0.004 in] washers set





### You will need:

- cross-head screwdriver
- flat-blade screwdriver
- metal file or milling machine
- solvent
- grease
- USB-Link, micro USB-Cable and PC / MAC or OTG cable and Android device

### Follow the steps below in order to mount the TITAN drop-in module:

1. Remove the gearbox from the AEG body.
2. Disassemble your gearbox, take out all the internals.

3. Clean the gearbox case using solvent.



4. Detach the drop-in module carefully.

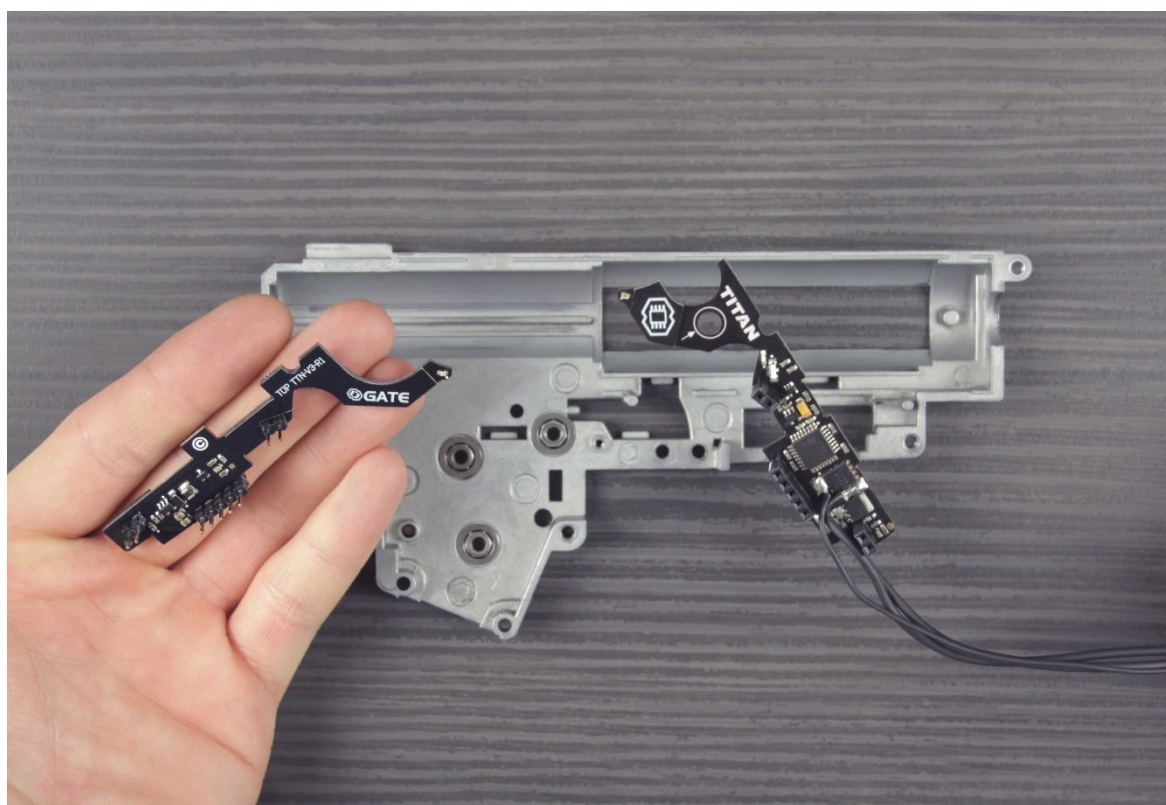

5. Route the wires through gearbox shell from the inside.

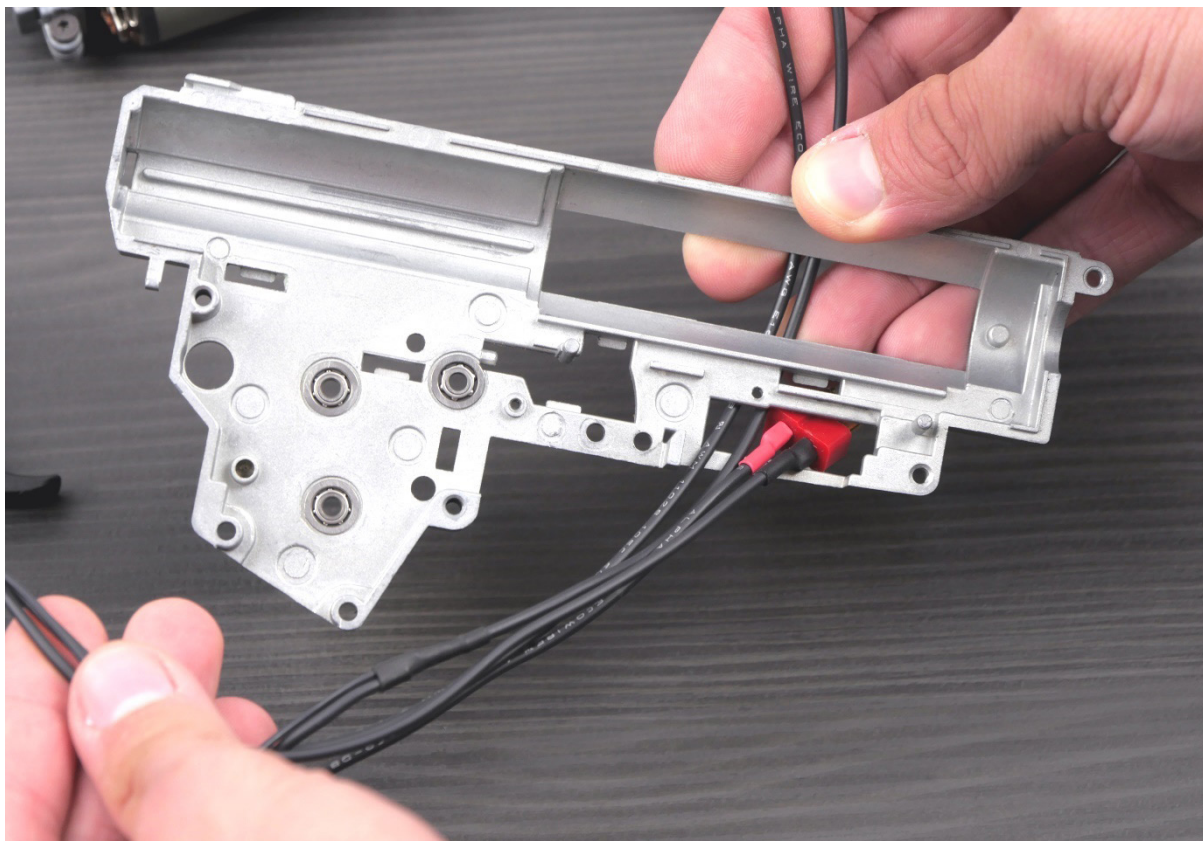

6. Place the wires in gearbox shell so as the unit can fit properly without any resistance.



7. Place the bottom board on the bottom part of the gearbox. Do not use a screw yet. Check if the bottom board is laid flat in the gearbox.

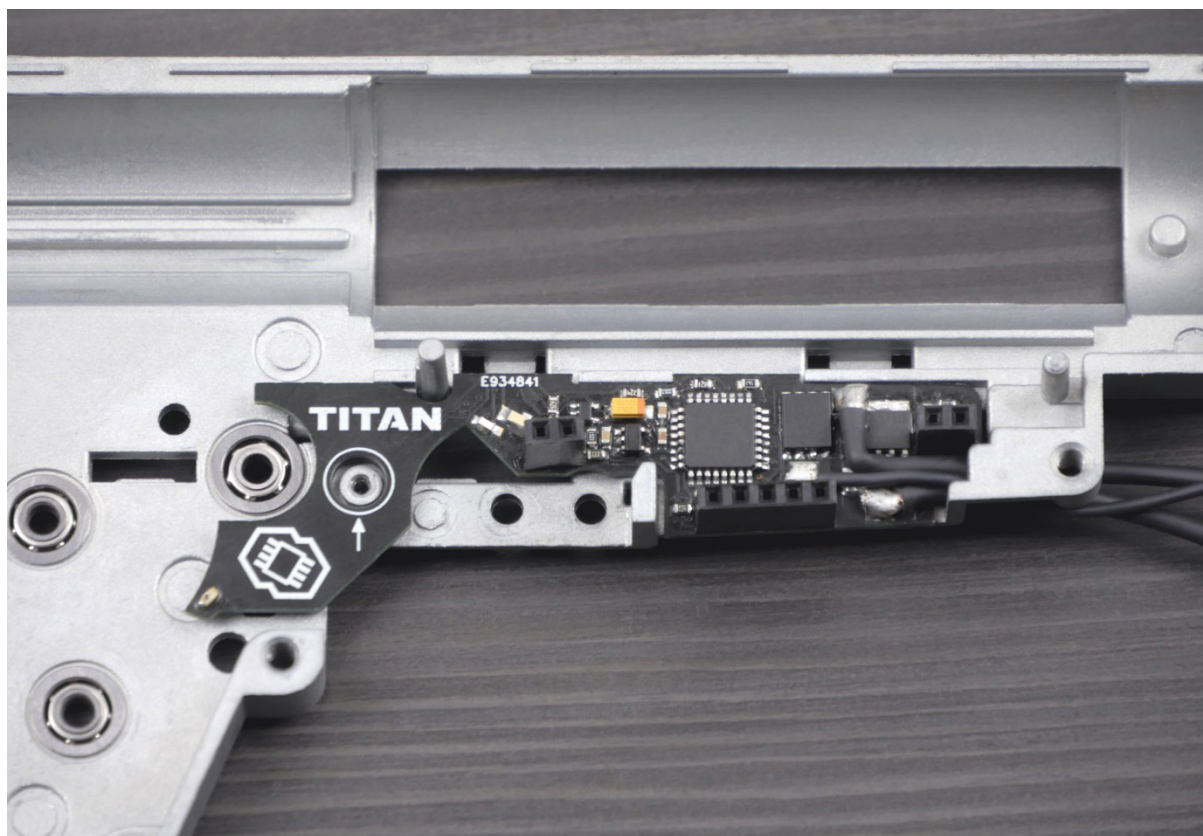

8. Make sure the electronic components do not touch the gearbox case.

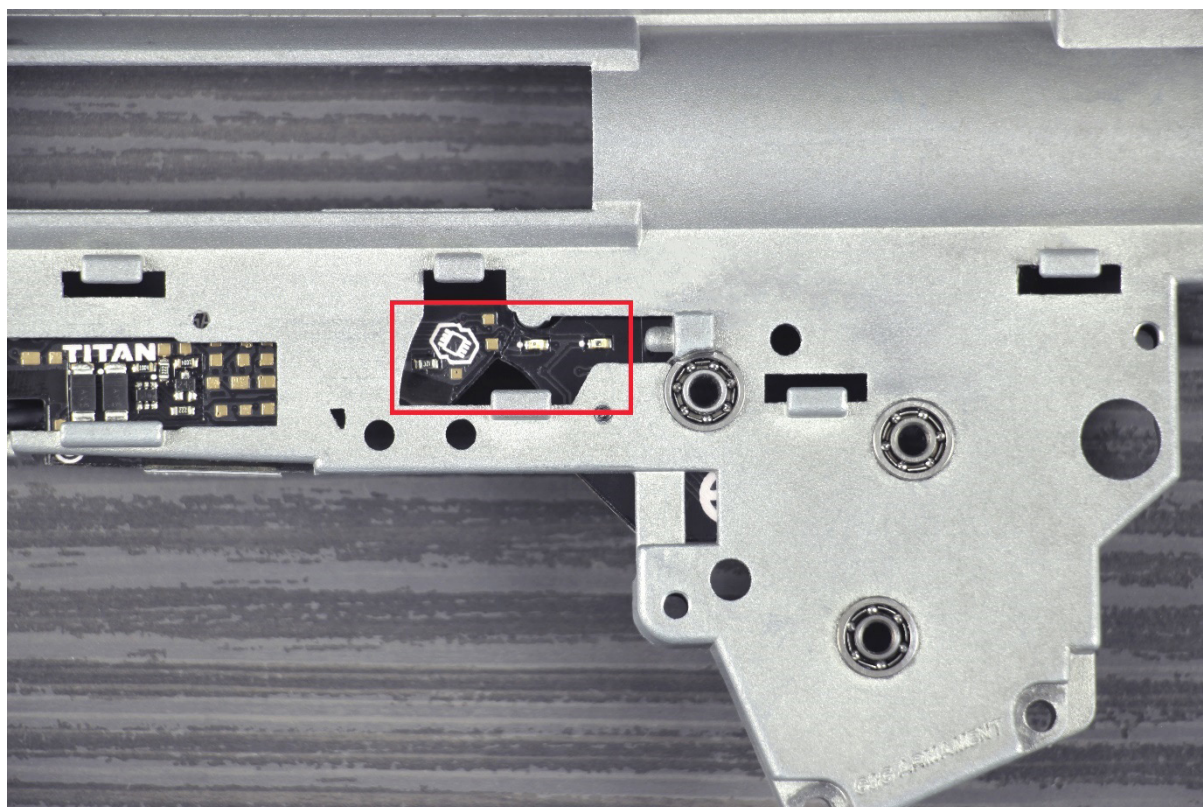

9. If the bottom board fits correctly, use a cut-off lever screw to stabilize the unit. Use also the included washers.

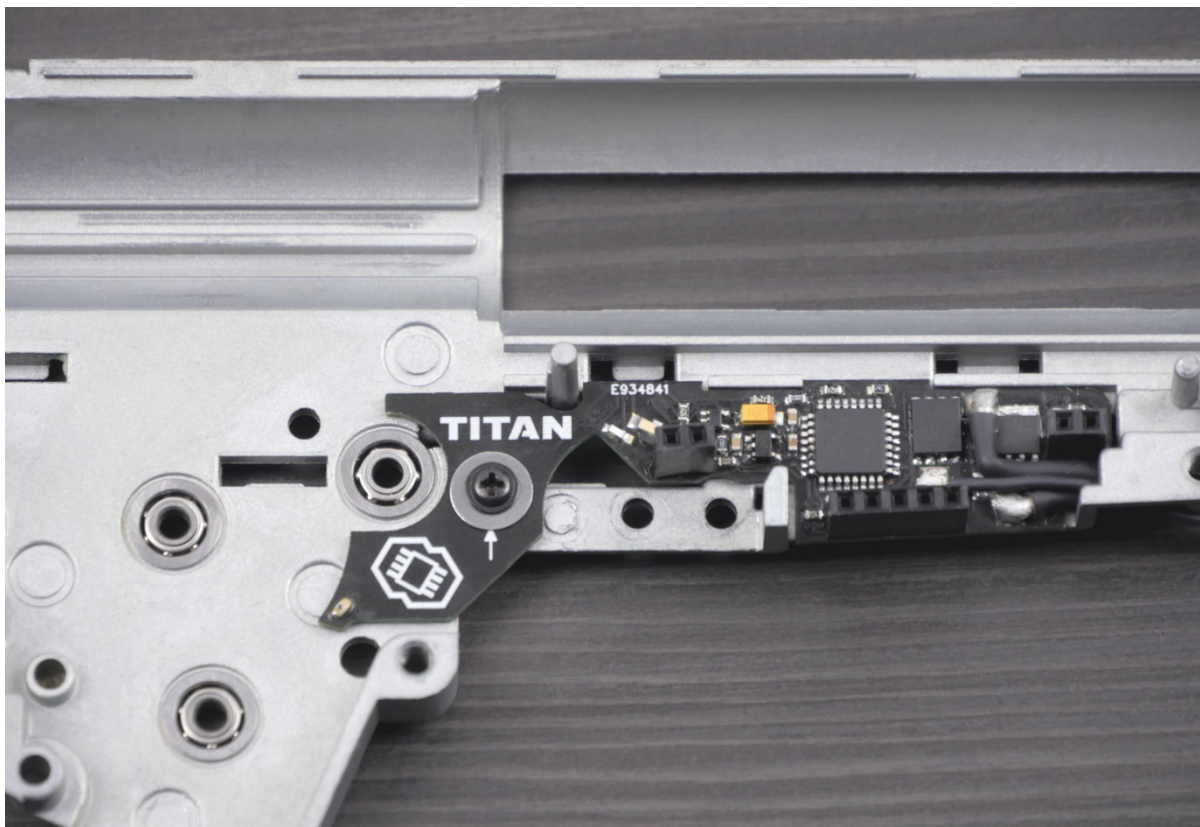

**i Notice**  
TITAN V3 does not require an insulation washer.

10. Check if the screw sticks out of the gearbox.

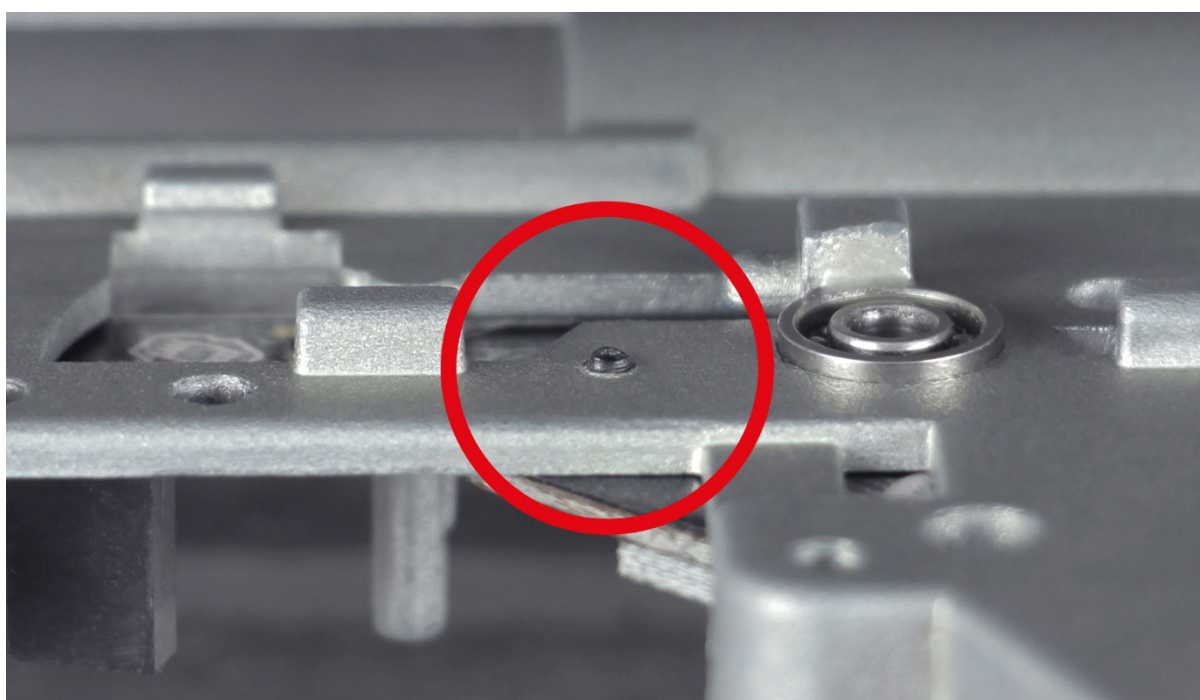

11. If so, add metal washer(s) included in the kit.

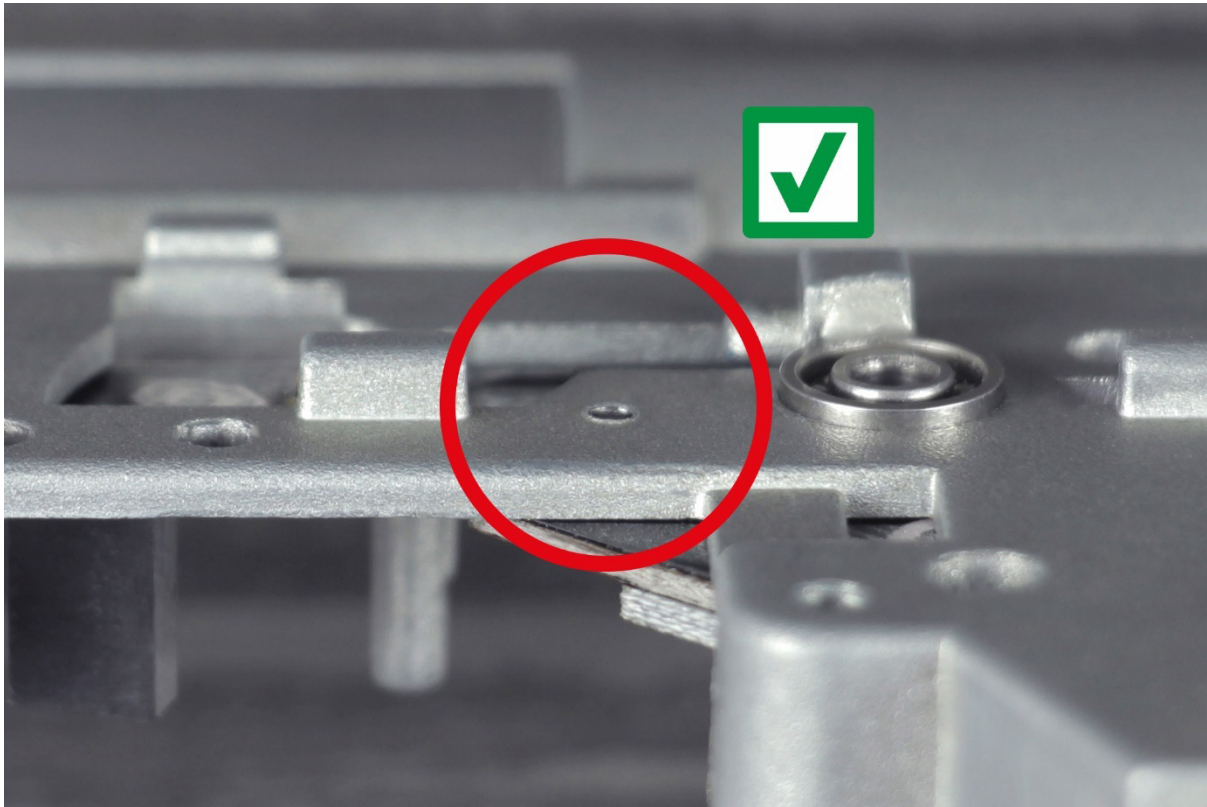

12. Check if the top board fits gearbox without any problems.

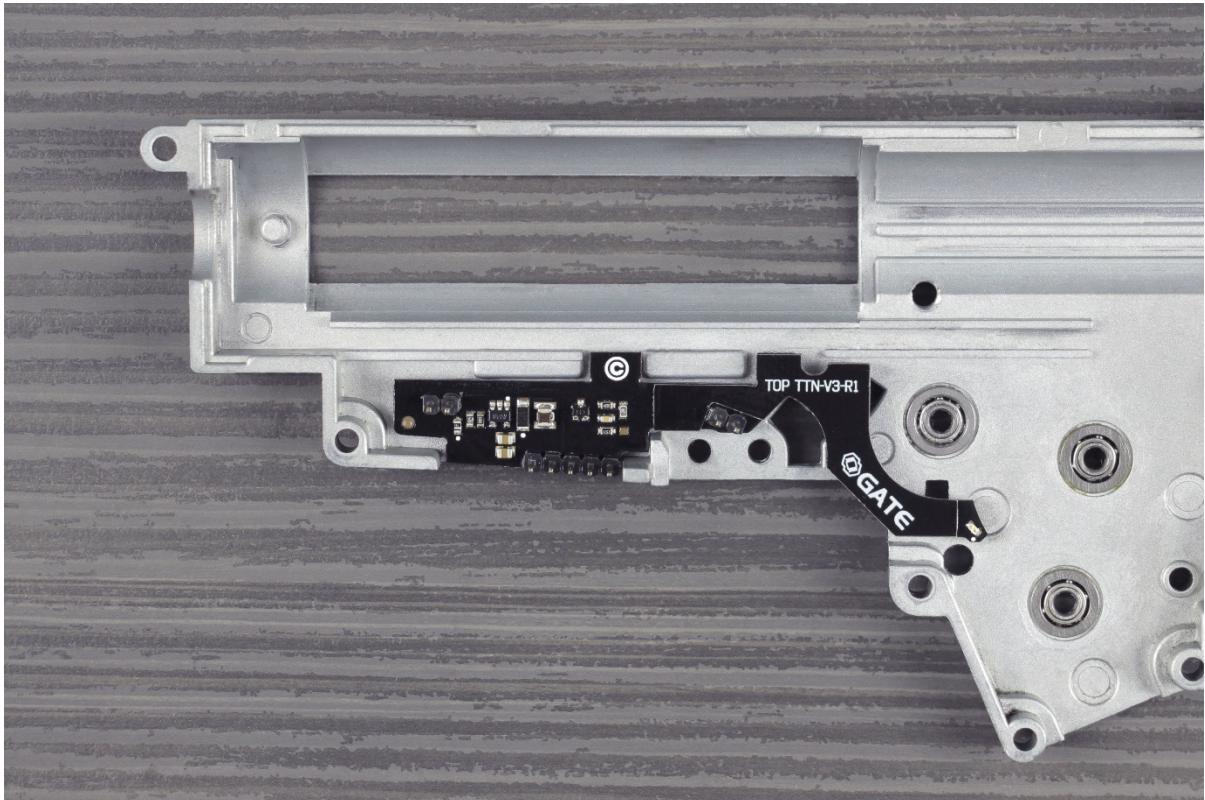

13. Loosen the screw. Adjust the position of the bottom board. The distance between the board and the bearing should be similar as indicated in the marked area.

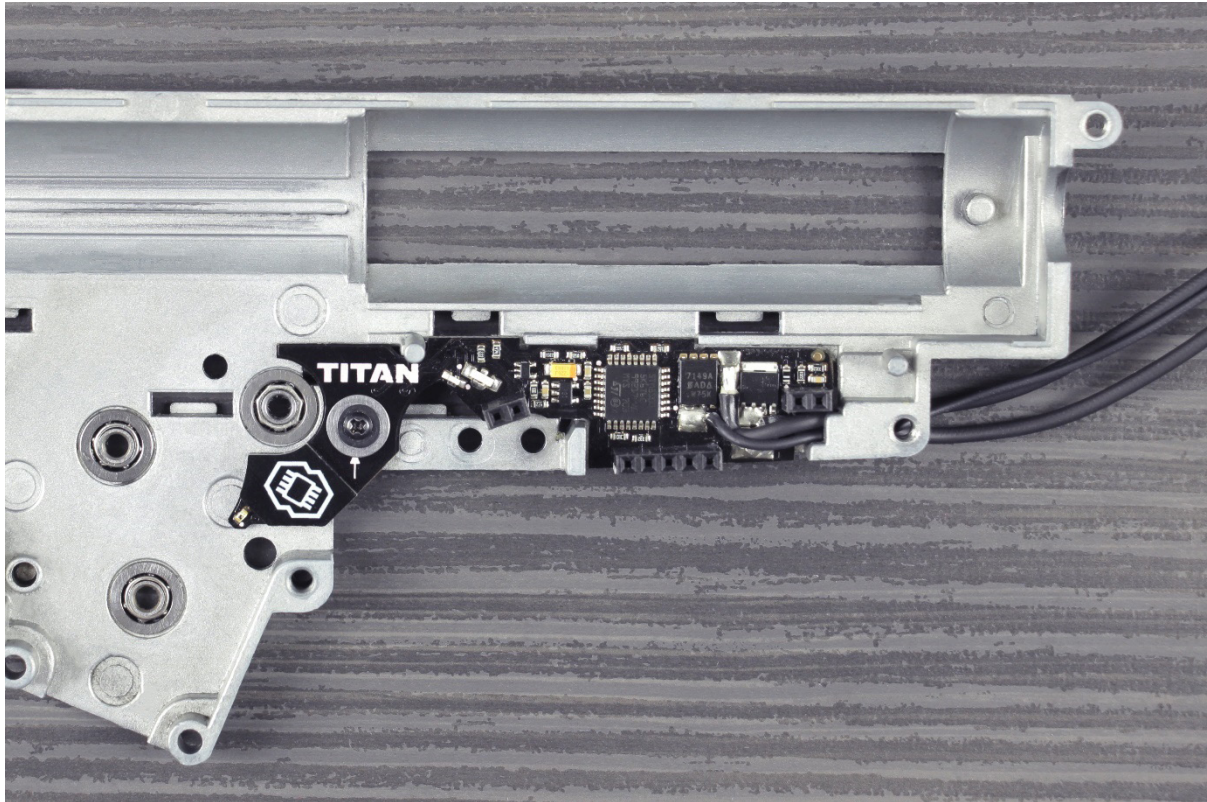

**Notice**

Sector gear sensor placement is very important.



14. Mount the sector gear and top TITAN board. Make sure that the gear does not touch TITAN.

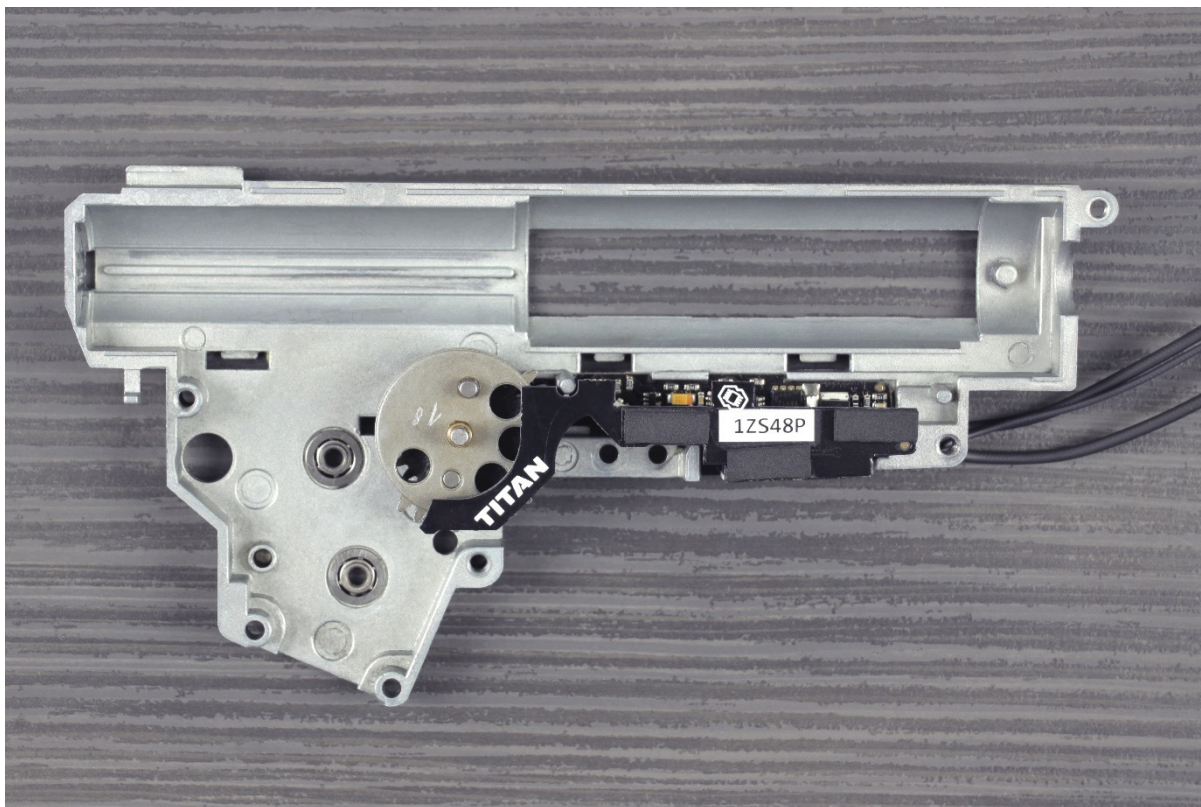

15. Close the gearbox. Use at least two screws.

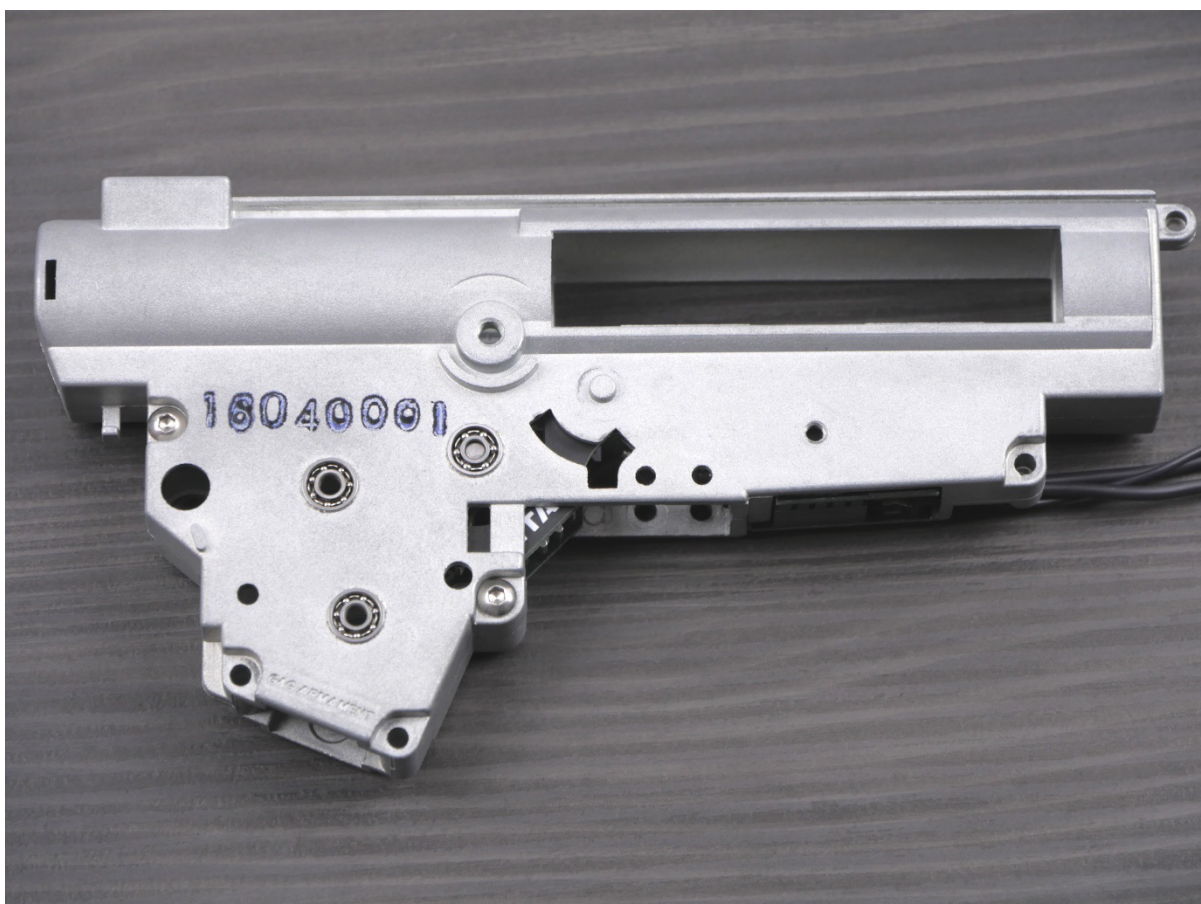



16. Connect TITAN to your PC through USB-Link. Start the GATE Control Station App.

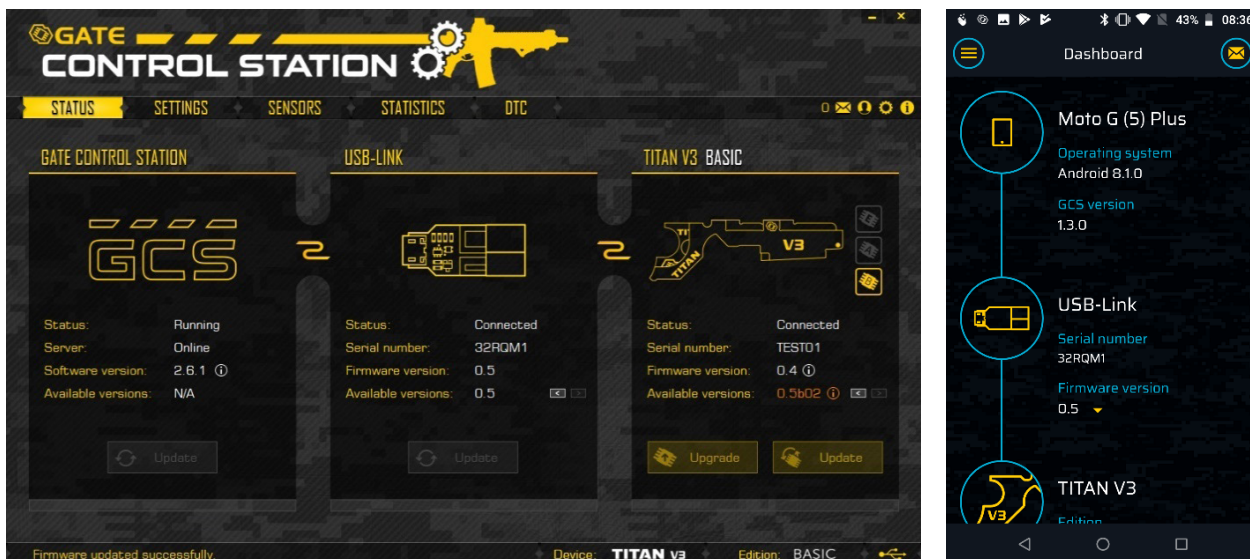

17. Turn the gear slowly to check if the sensor detects teeth. Keep in mind that the TITAN reads the sensors much quicker than the GCS.



18. Use solvent to clean trigger elements. Next, paste the smaller sticker (trigger sticker) on the flat surface.

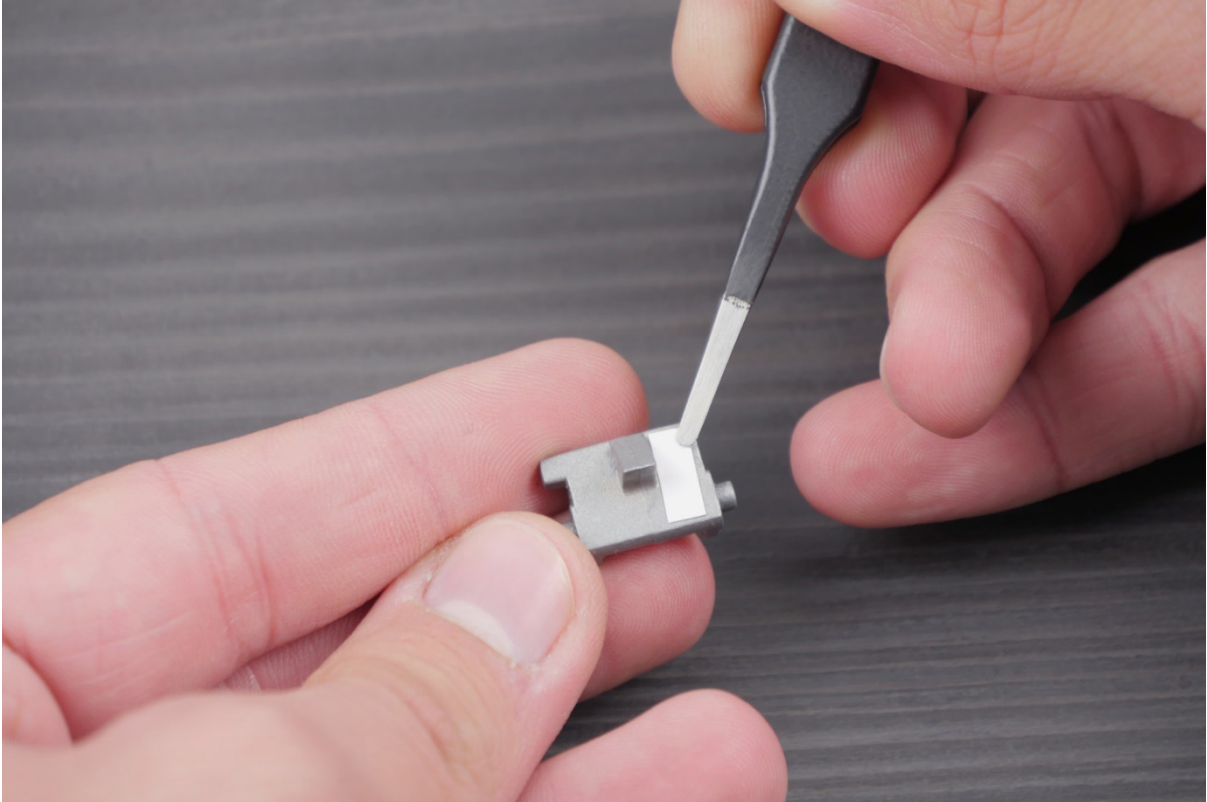

19. Paste one trigger anti-backlash sticker inside the moving element of the trigger.

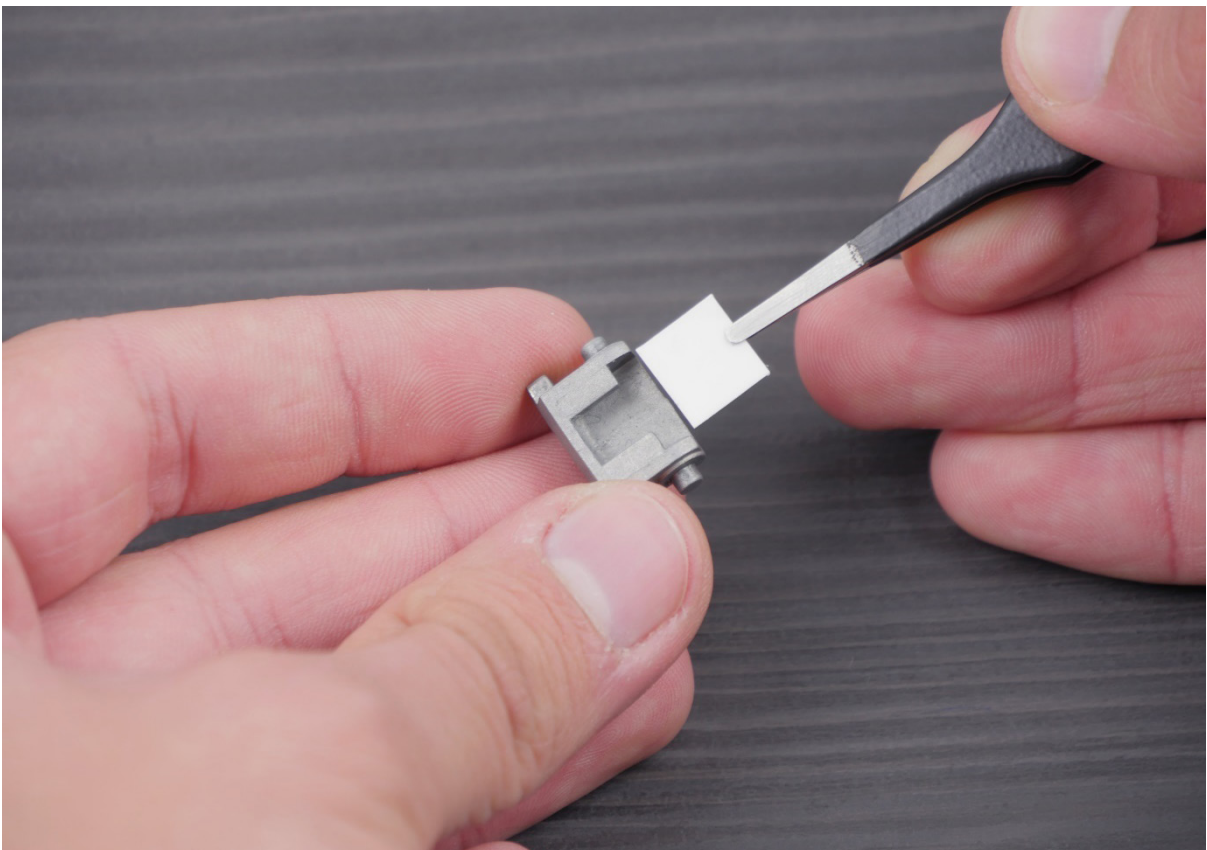

i

### Notice

The stickers reduce space between the trigger and the moving element, so as the trigger works more precisely. Installation kit includes three stickers of different thickness.

20. After pasting the first sticker, assemble both trigger elements and estimate the clearance between them. If you feel that there is still some clearance, you can use next stickers. Remember that trigger should work smoothly.

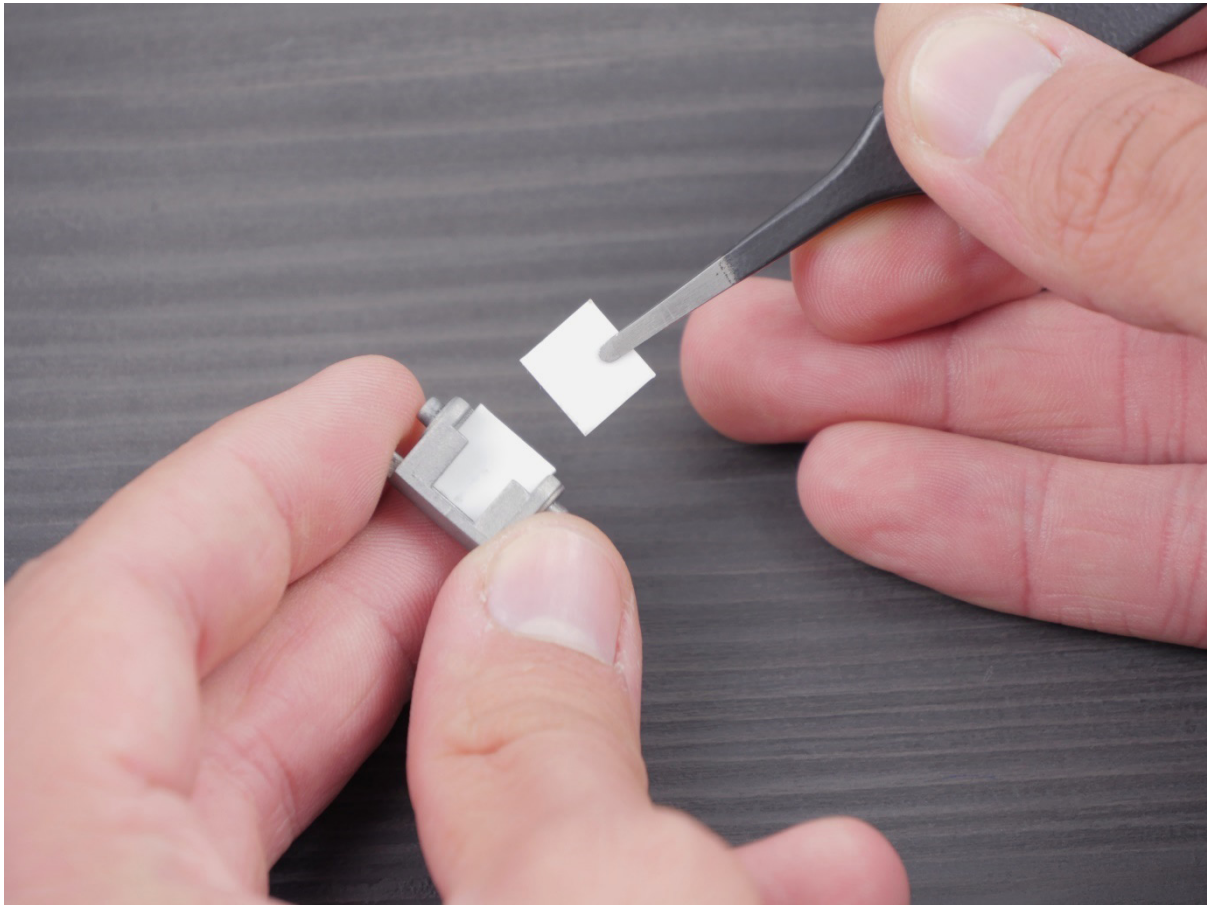

21. All the steps performed 'inside the gearbox' are finished. Now you can assemble the gearbox. Do not use too much grease. In a critical situation, excessive grease may cover a sensor.



22. In some replicas (G36, UMP, etc.) you need to modify the mechanical trigger lock, because it is too long and touches the TITAN top board. In this case, grind the protruding element by around 1.5/2mm [0.06/0.08 in].

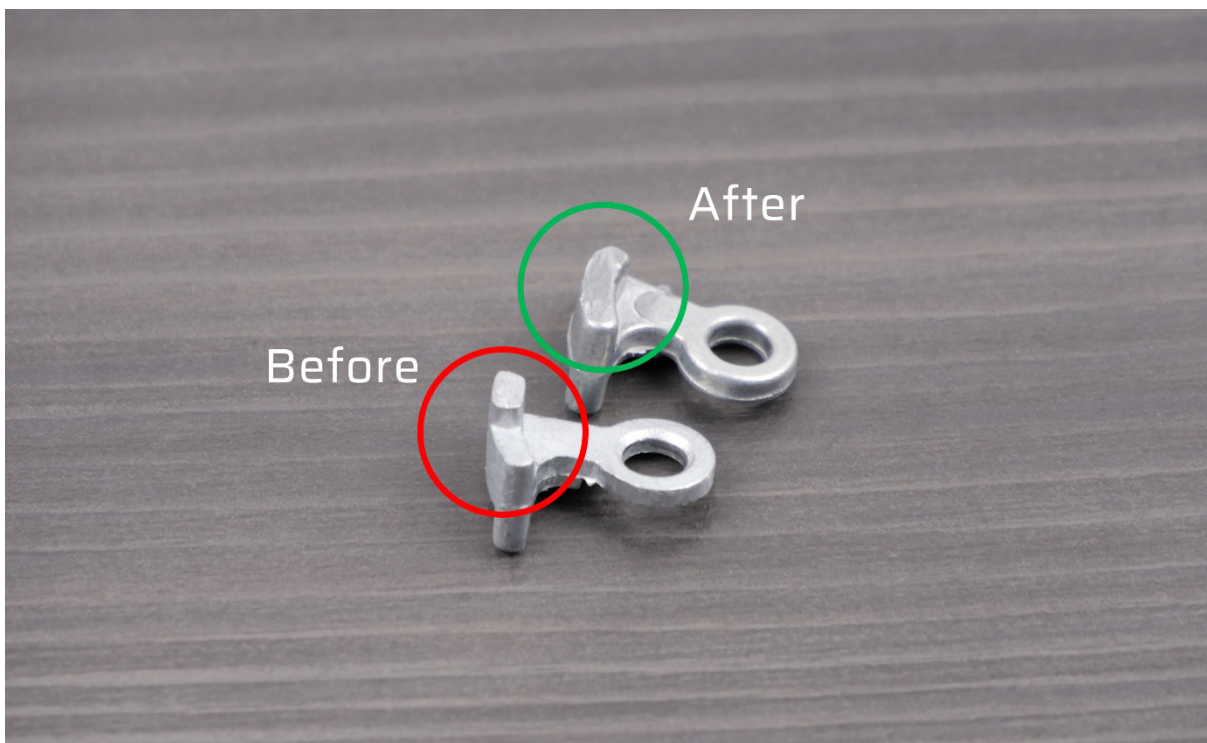

23. After the modification, check if the mechanical trigger lock touches the TITAN top board. If it does not touch the board, you can take the next step.



24. Install the remaining external gearbox components and start the wiring placement. You can use the picture below or your previous wiring as a suggestion.



25. Prepare the selector plate following the steps below. If the plate is a standard one (AK, most of G36, etc.), paste the sticker like in the picture below. If necessary, enlarge the hole in the plate - space between the selector plate border and the sticker border should be approximately 10mm [0.4 in].



26. If there are any issues with the sticker adhesion, modify the selector plate.



27. Finish the gearbox assembly and put it in the replica body. Next, connect TITAN to PC using USB-Link and perform the sensor calibration following the calibration instructions from GATE Control Station.



**Caution**  
Calibrate the trigger and selector sensors only after the gearbox is mounted in the replica body.

## 8. TITAN V2 NGRS

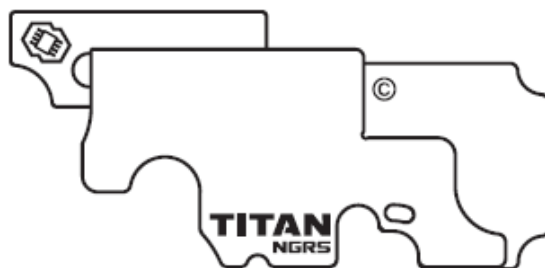

TITAN V2 NGRS™ is an AEG Control System for Tokyo Marui V2 Next Generation Recoil Shock gearboxes.

Transform your Tokyo Marui Next Generation AEG into an advanced training weapon system. Adjust your weapon and check the Statistics using USB-Link and GATE Control Station app for PC, MAC and Android devices. TITAN V2 NGRS has the whole new trigger sensor, which allows to set hair trigger with ludicrous precision: even 50 sensitivity levels for first millimeter of trigger movement. The innovative 3rd generation trigger sensor offers you even 460 possible sensitivity settings. Gain a unique tactical advantage thanks to the extremely fast trigger response and lots of other useful functions. Boost your AEG with computerized technology. Give your AEG a new lease of life!

**TITAN V2 NGRS has the following sensors:**

- 2 gear sensors
- 1 fire selector sensor
- 1 trigger sensor
- 1 bolt catch sensor

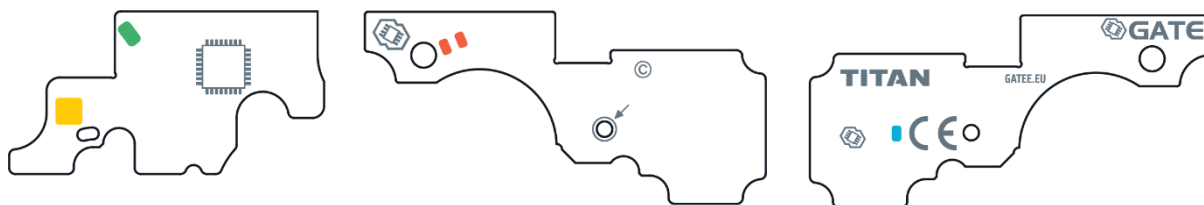



# SETS COMPARISON

**TITAN**  
V2 NGR5



## SET INCLUDES

## ADVANCED SET

## BASIC MODULE

TITAN with ADVANCED firmware edition	✓	✗
TITAN with BASIC firmware edition	✗	✓
USB-Link	✓	✗
USB-A cable for USB-Link	✓	✗
USB-C cable for USB-Link	✓	✗
Micro-USB cable for USB-Link	✓	✗
Titan Patch	✓	✗

## 8.1. TITAN Advanced Set

At once you purchase TITAN with ADVANCED firmware edition, USB-Link and USB cables allowing to connect TITAN to PC/MAC as well as Android device.

The ADVANCED firmware edition offers wide variety of functions and is dedicated for those who like complex solutions. It enables access to the Statistics and TITAN World Rankings. To learn all the differences between firmware editions, please check the comparison table.



## Advanced Set contents:

1. TITAN V2 NGRS with ADVANCED firmware edition (rear or front wired)
2. USB-Link for GATE Control Station™ App
3. USB-A Cable for USB-Link [1.5m / 4ft 11in]
4. USB-C Cable for USB-Link [0.6m / 1ft 11in]
5. Micro-USB Cable for USB-Link [0.6m / 1ft 11in]
6. Installation Kit
7. TITAN Patch
8. Quickstart Guide

## 8.2. TITAN Basic Module

The best if you long for having TITAN in two or more airsoft guns. Then you do not need the second USB-Link from the Advanced or Complete set. It includes TITAN with BASIC firmware edition. Basic Module is also suitable for you if you decide to purchase the USB-Link separately.

The BASIC firmware edition is an economic version with limited number of functions, dedicated for those who prefer simplicity but require highest quality. If you decide to have more functions, there is always option to upgrade firmware from BASIC to ADVANCED.







**Caution**

Placing the washers in wrong order will cause a short circuit and permanent damage to the TITAN, what is not covered by the warranty.

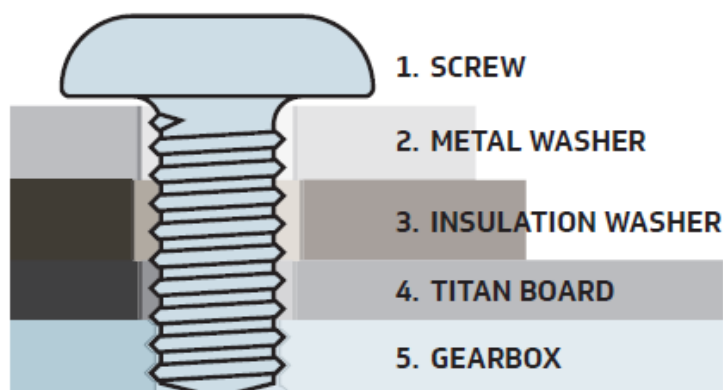
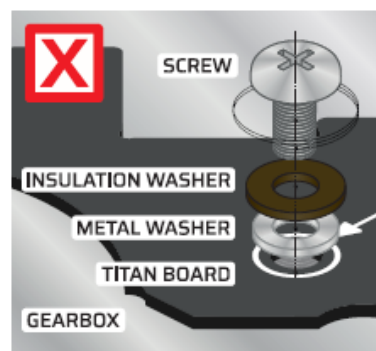
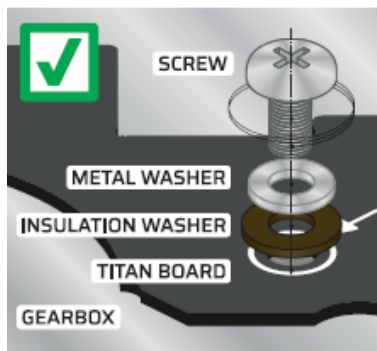

**Caution**

Do not use a cut-off lever screw to secure the TITAN board.

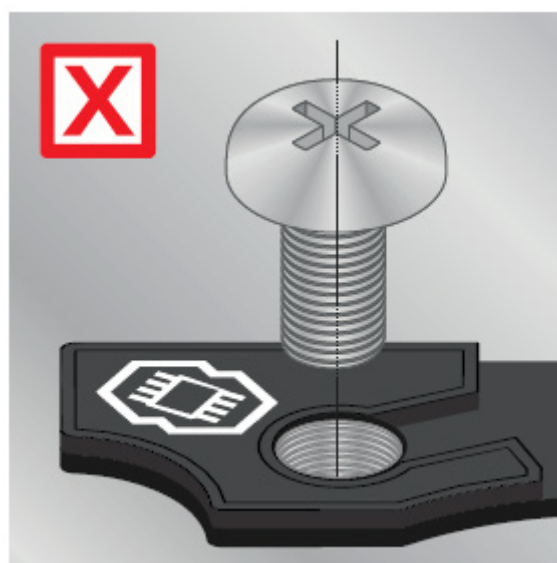



### Caution

The improper placement of wiring under motor gear can cause insulation damage and a short circuit. In order to secure the wires properly we recommend to perform a gearbox modification as shown in the photos below.

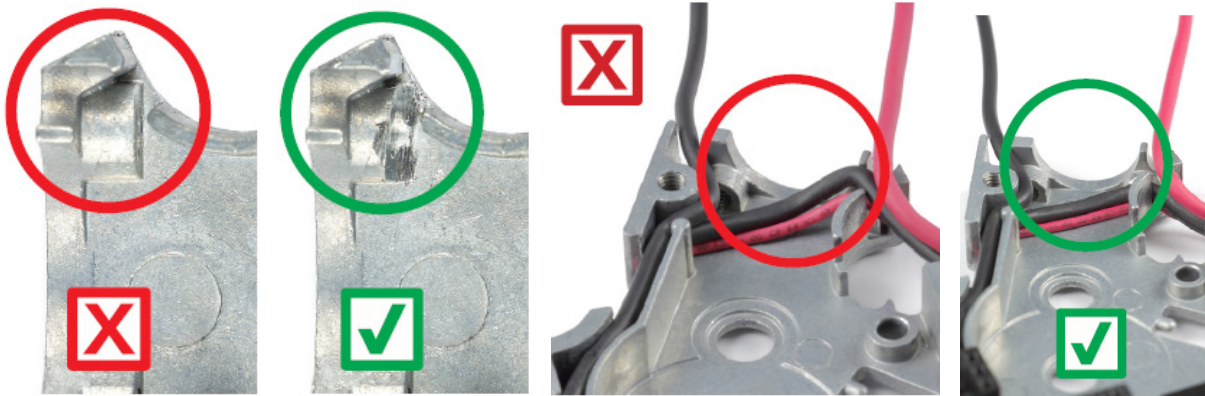

### Notice

The selector plate requires modification. Place the selector sticker according to the photos below. The sticker position is very important.

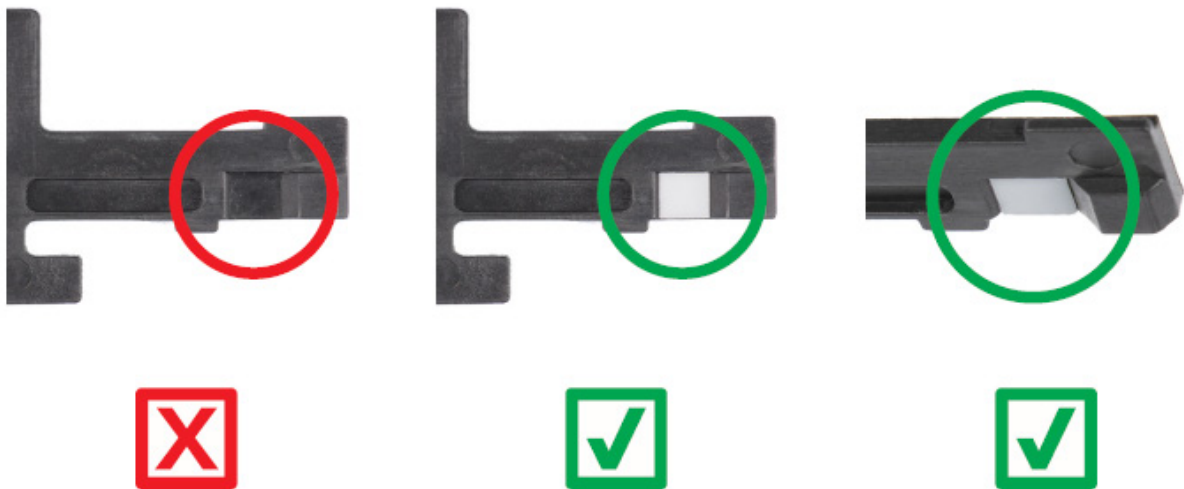

### Notice

In case of TITAN V2 NGRS pre-cocking setup via fire selector is different than in case of TITAN V2, due to presence of mechanical trigger safety lever. In order to set the pre-cocking:

1. Switch fire selector to SEMI, fire the shot and keep the trigger pulled.
2. While the trigger is pulled you are able to select pre-cocking mode:

- SEMI = Pre-cocking OFF
- AUTO = Pre-cocking AUTO

Setting pre-cocking mode to 'TRIGGER' option can be done only via GCS.

## 8.4. Installation

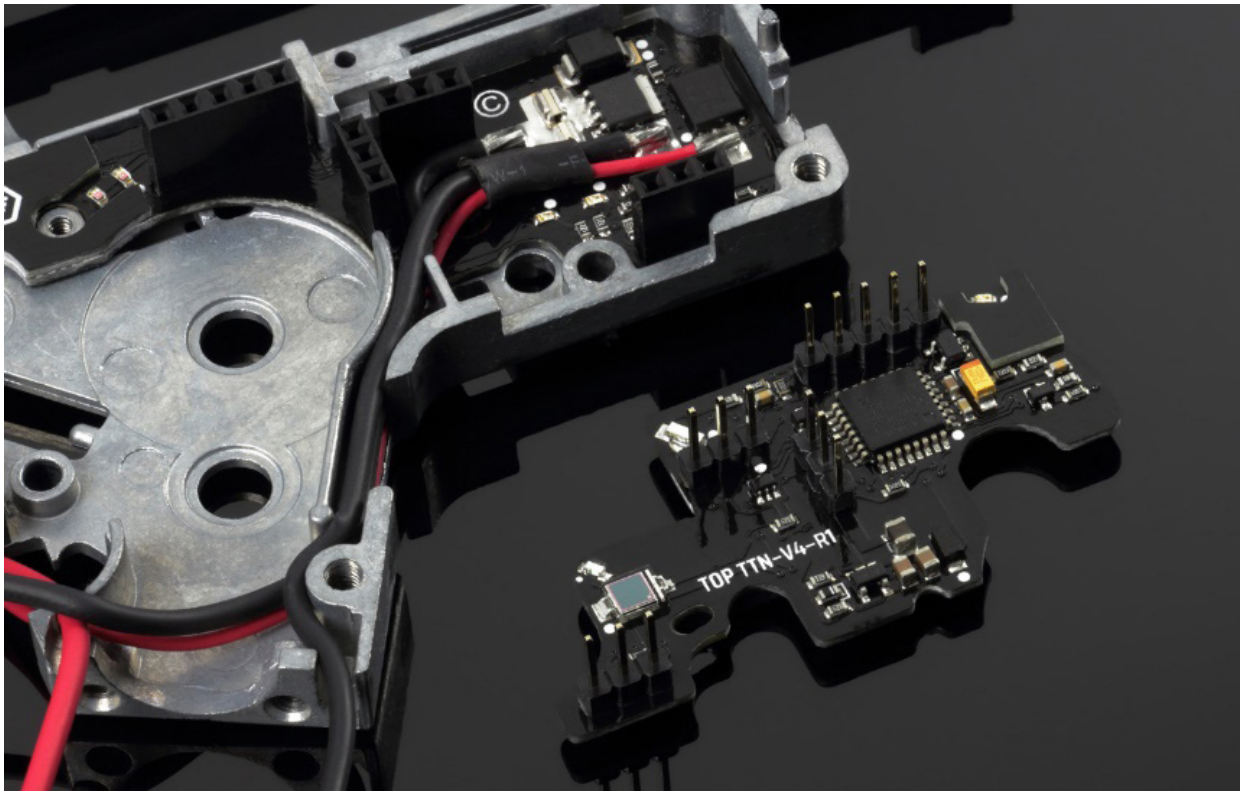

### Installation kit contents:

1. M2 steel washer (2 pcs)
2. M2 pressboard washer (2 pcs)
3. Selector plate sticker (6 pcs)
4. Female deans-t connector
5. Male deans-t connector
6. 4.8mm x 12mm [0.19in x 0.47in] black heat-shrink tube (2 pcs)
7. 4.8mm x 12mm [0.19in x 0.47in] red heat-shrink tube (2 pcs)
8. 3.2mm x 18mm [0.13in x 0.71in] black heat-shrink tube
9. 3.2mm x 18mm [0.13in x 0.71in] red heat-shrink tube
10. 2.8mm x 0.5mm [0.11in x 0.02in] female terminal (2 pcs)



### You will need:

- cross-head screwdriver
- \*TORX
- flat-blade screwdriver
- metal file or milling machine
- solvent
- grease
- USB-Link, micro USB-Cable and PC / MAC or OTG cable and Android device

Follow the steps below in order to mount the TITAN drop-in module:

1. Remove the gearbox from the AEG body.
2. Disassemble your gearbox, take out all the internals.

3. Clean the gearbox case using solvent.

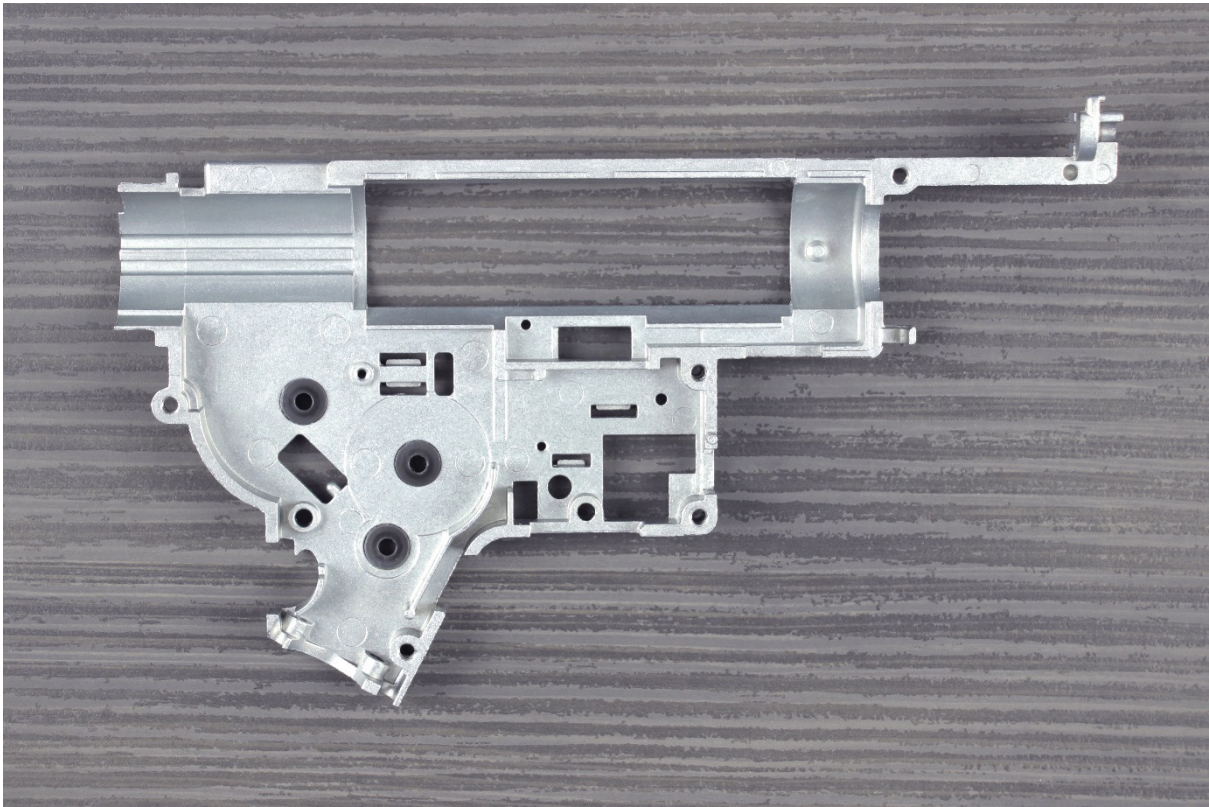

4. Detach the drop-in module carefully.

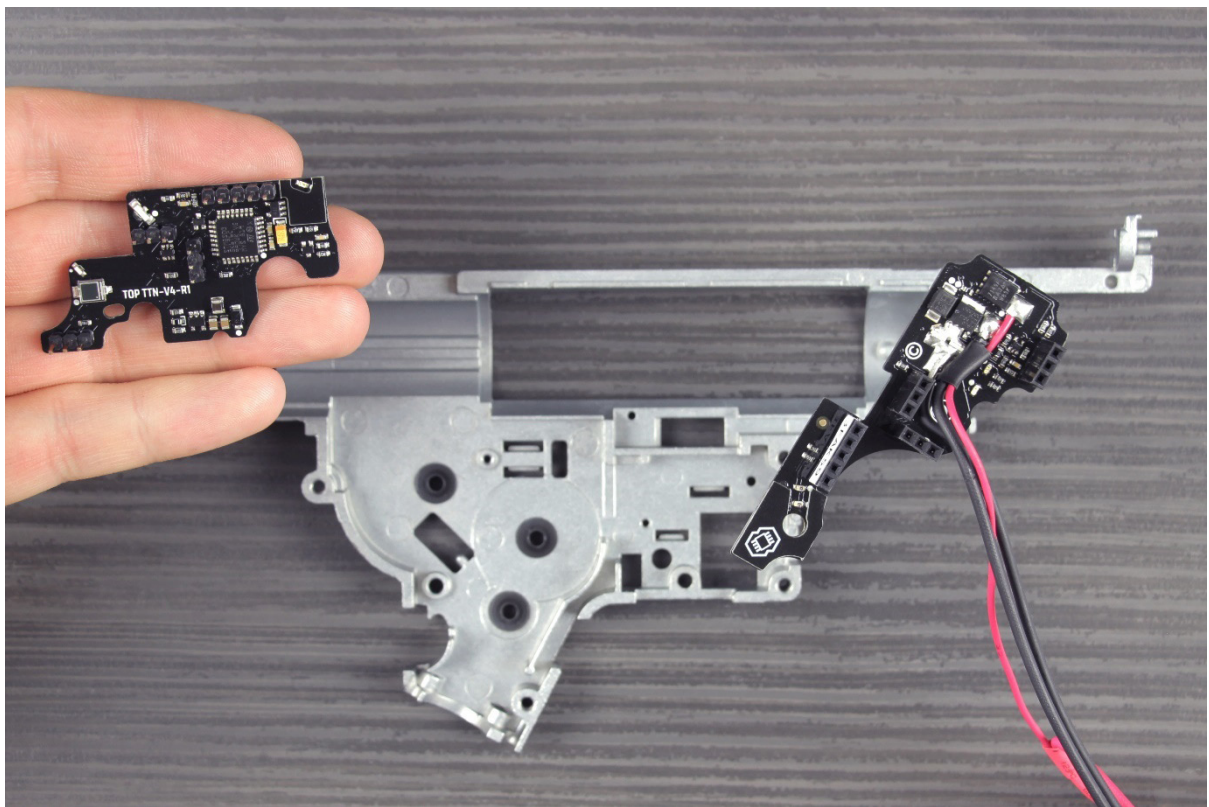



5. Place the bottom board on the bottom part of the gearbox. Do not use a screw yet. Check if the bottom board is laid flat in the gearbox.

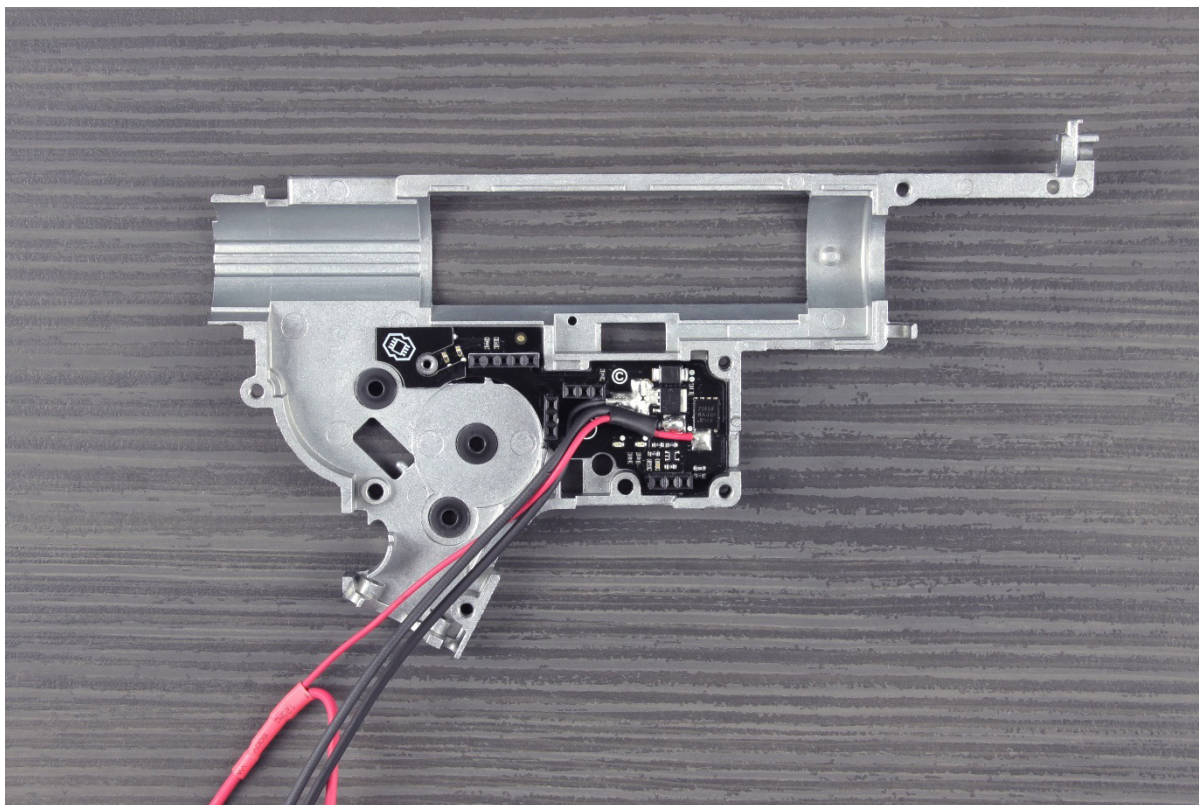

6. Make sure the electronic components do not touch the gearbox case.

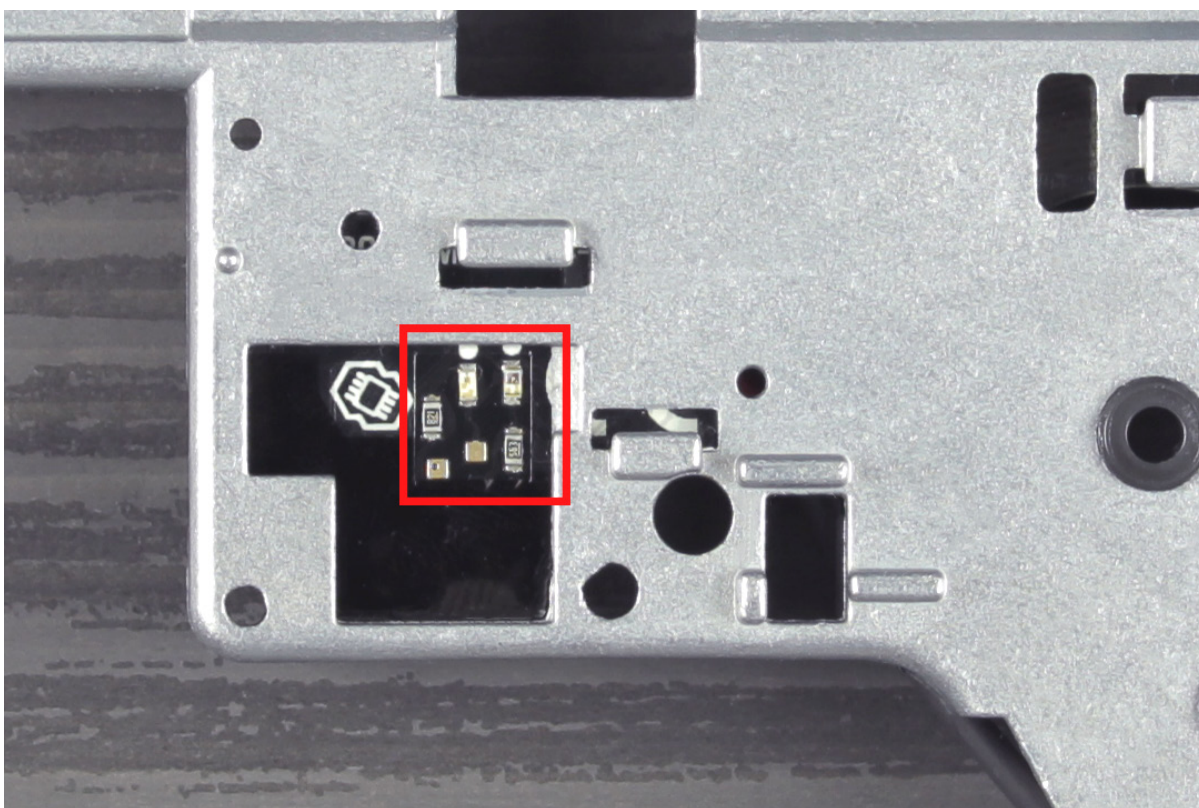

7. Use the insulation (black) washer from the kit. ATTENTION! The insulation washer must protect the circuit board. The metal screw and metal washer cannot touch the board directly. It can result in short circuit and TITAN damage what is not covered by the warranty.

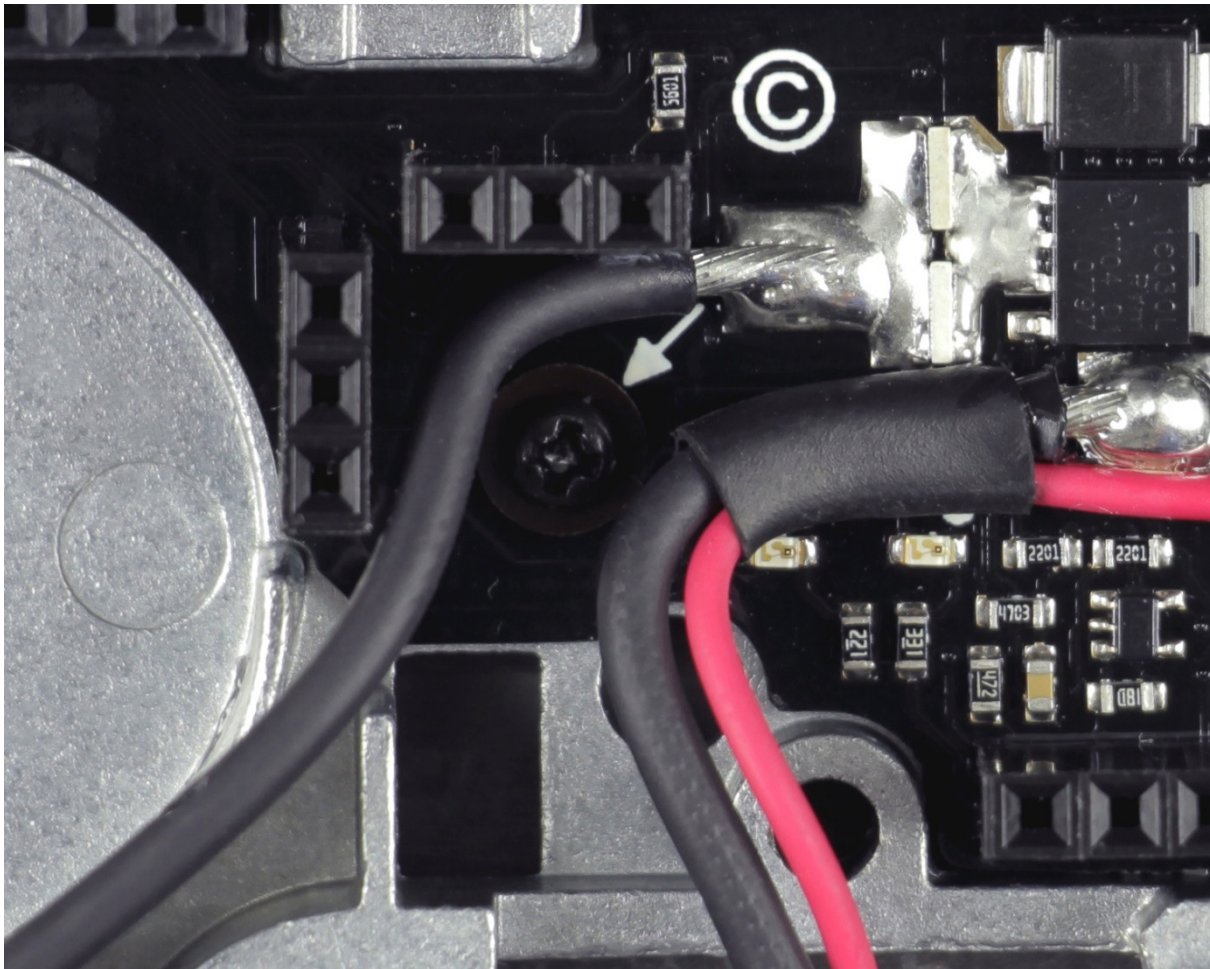

8. Screw on the bottom board to the case. Use the original screw or the one from the TITAN kit.

9. Check if the screw sticks out of the gearbox.

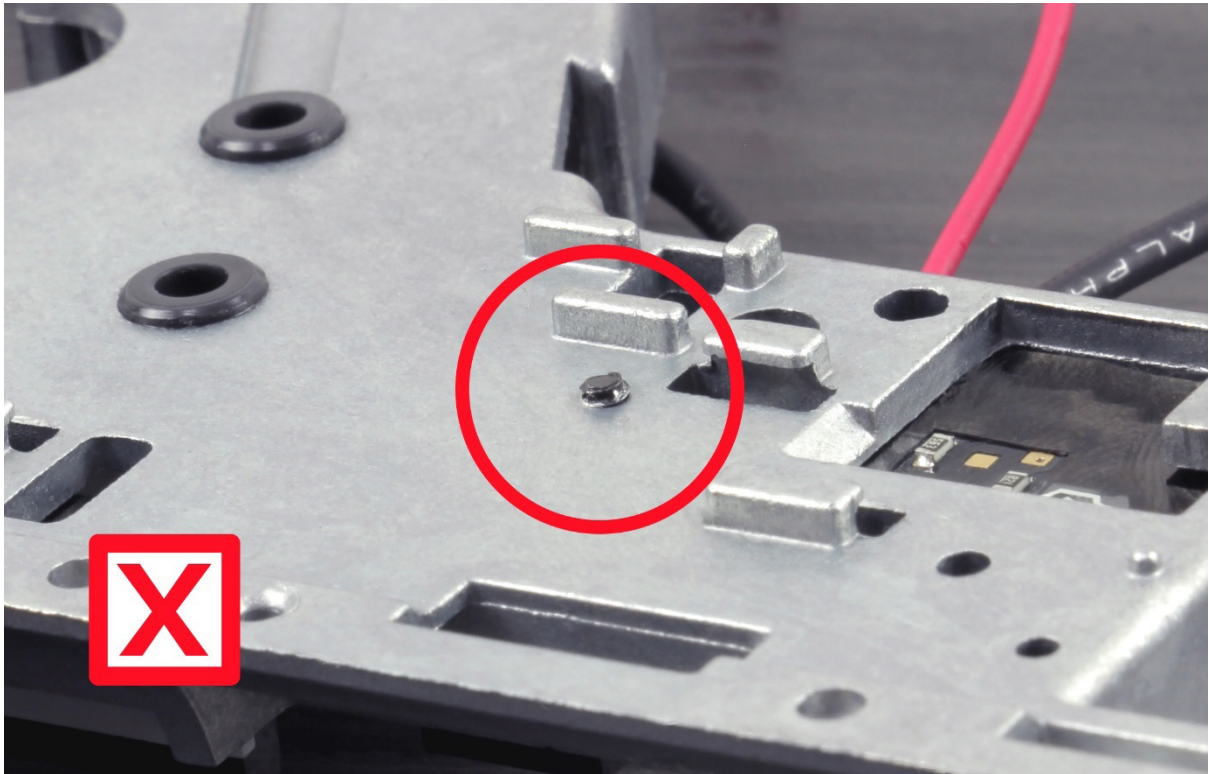

10. If so, add metal washer(s) included in the kit. Make sure that the metal washer is placed between the screw and the insulation washer. It cannot touch the circuit board directly.

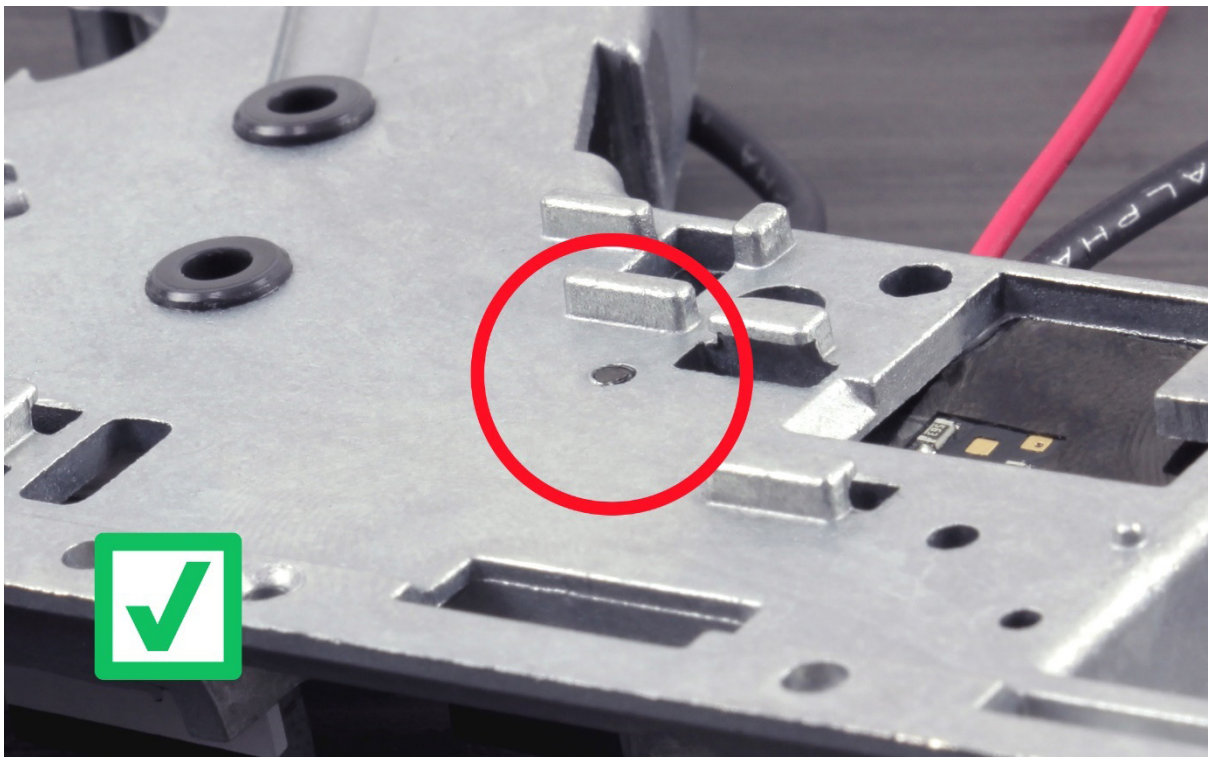

11. Check if the top board fits gearbox without any problems.

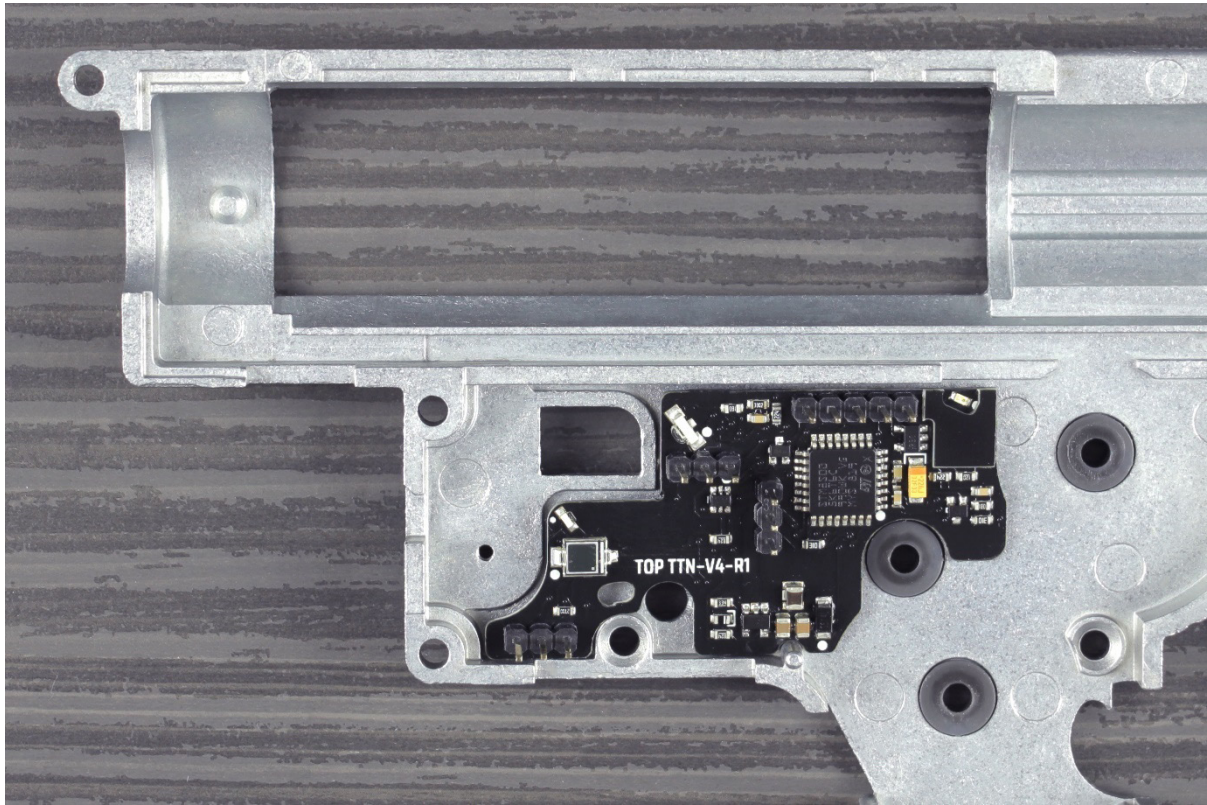

12. Make sure the marked areas are not covered by board or wires. Check if sensors are clean.

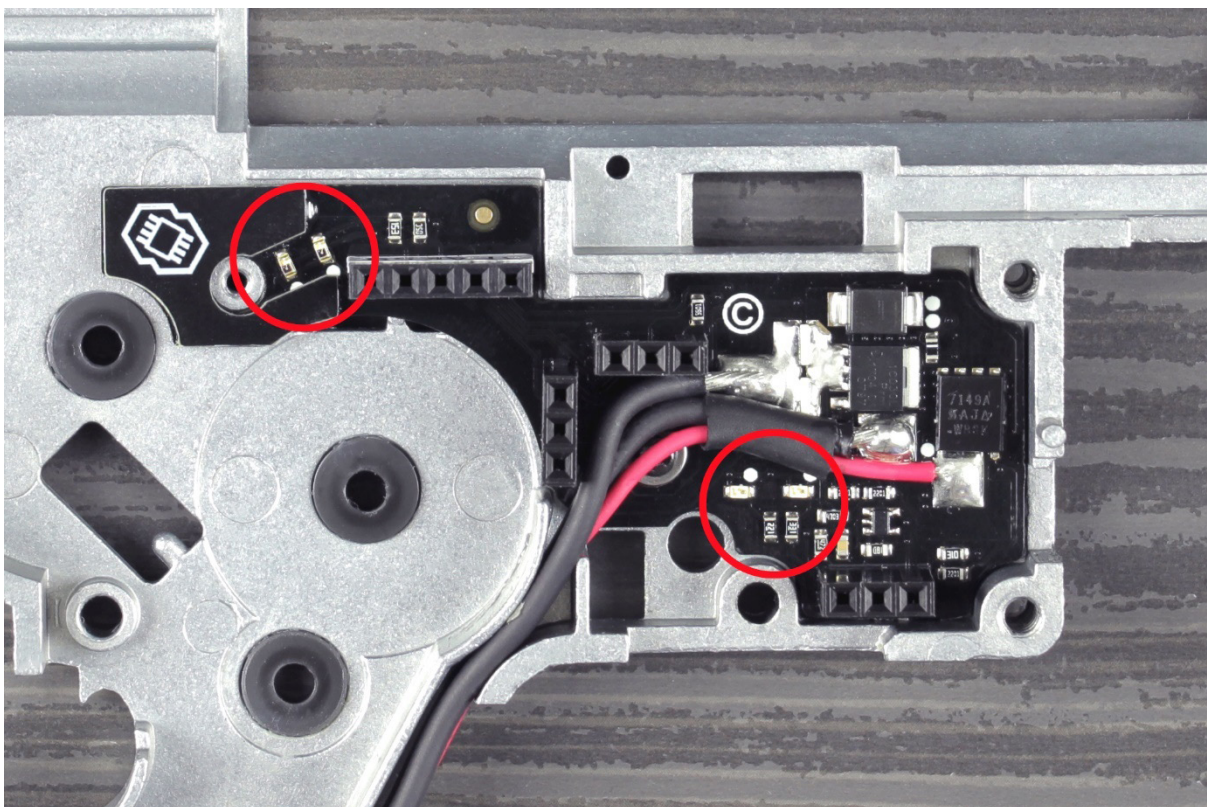

13. Place the wires in the gearbox shell, in exactly the same way as in the picture. The order is important.

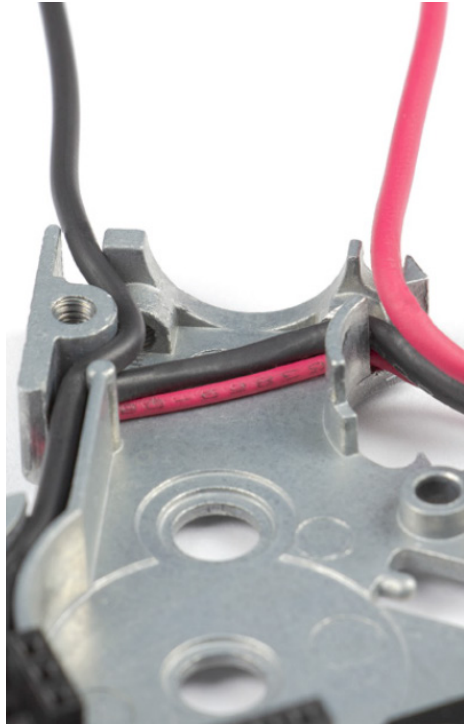

14. Check if both parts of the gearbox fit together perfectly.

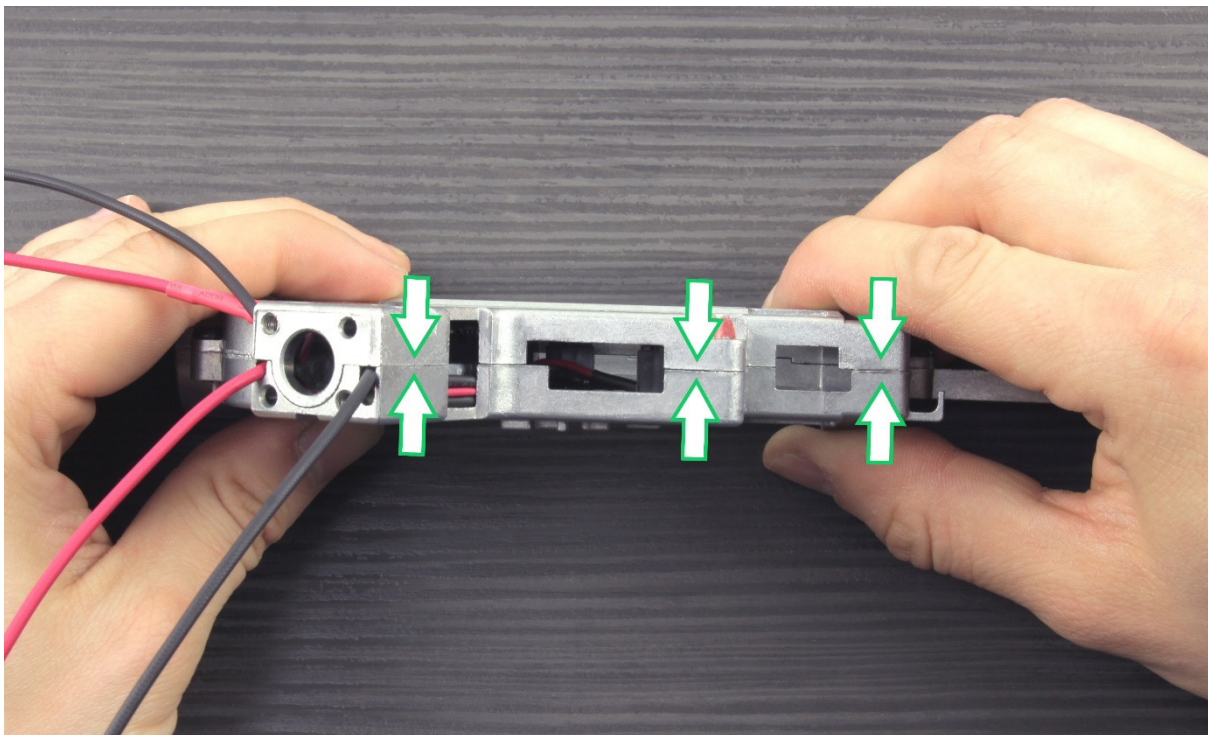

15. Mount the sector gear and top TITAN board. Make sure that the gear does not touch TITAN.

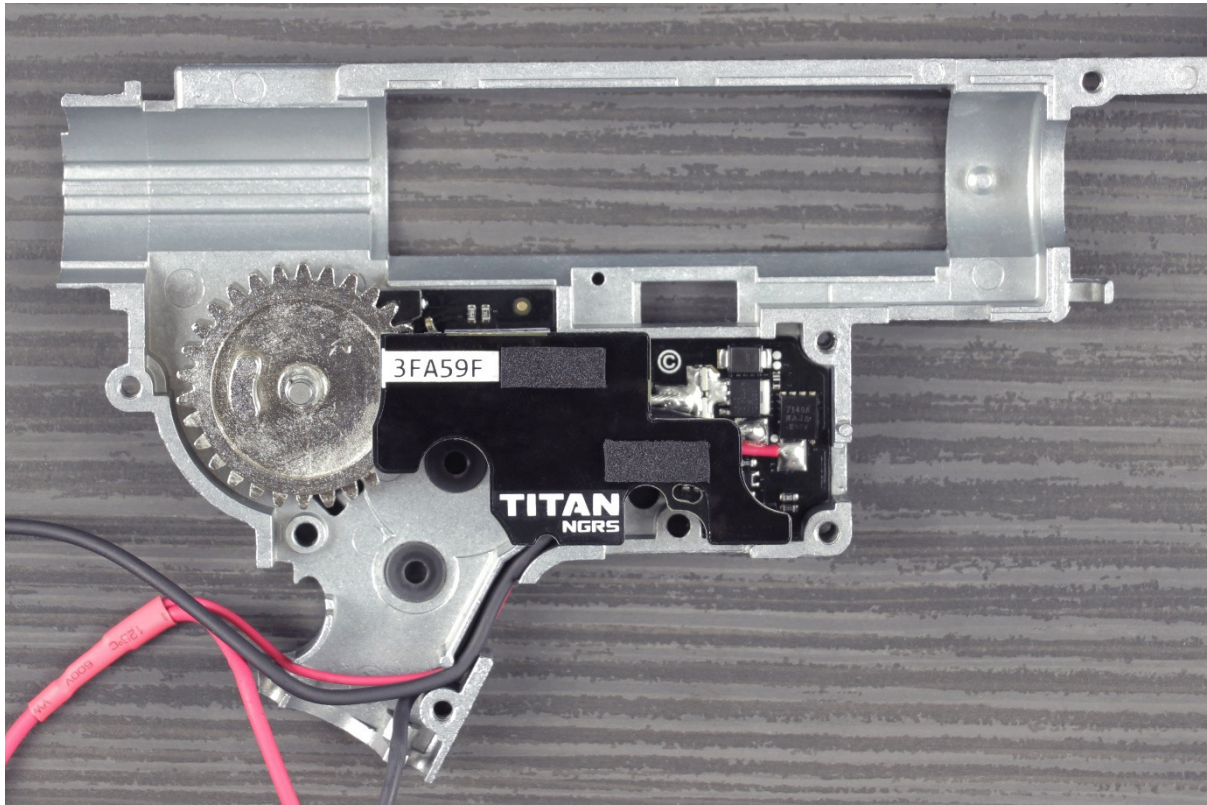

16. Close the gearbox. Tighten at least three screws.

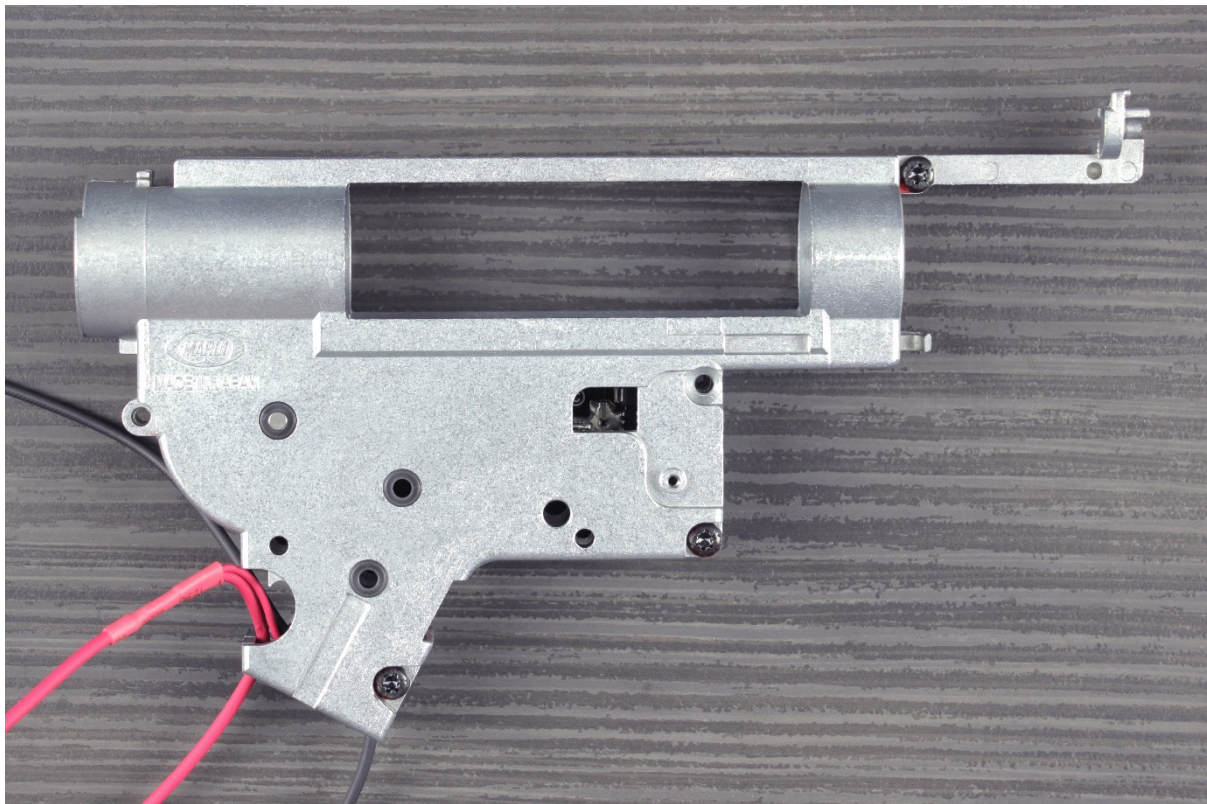

17. Connect the unit with GATE Control Station using USB cable and USB-Link (do not solder Deans-T connectors yet).

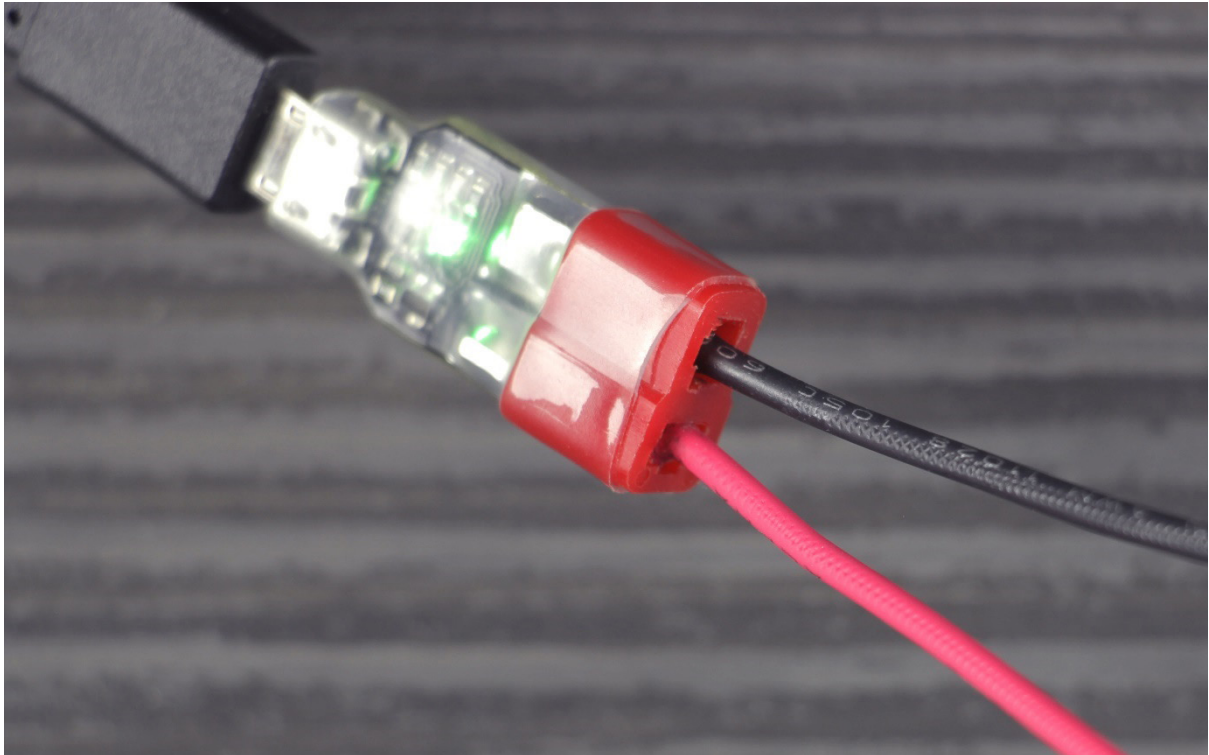

18. Go to Sensors TAB. While moving the gear, observe what happens with the FULL SECTION/HALF SECTION icons and gear sensors. Please note that TITAN V2 NGRS is not compatible with Tactical Programming Card.

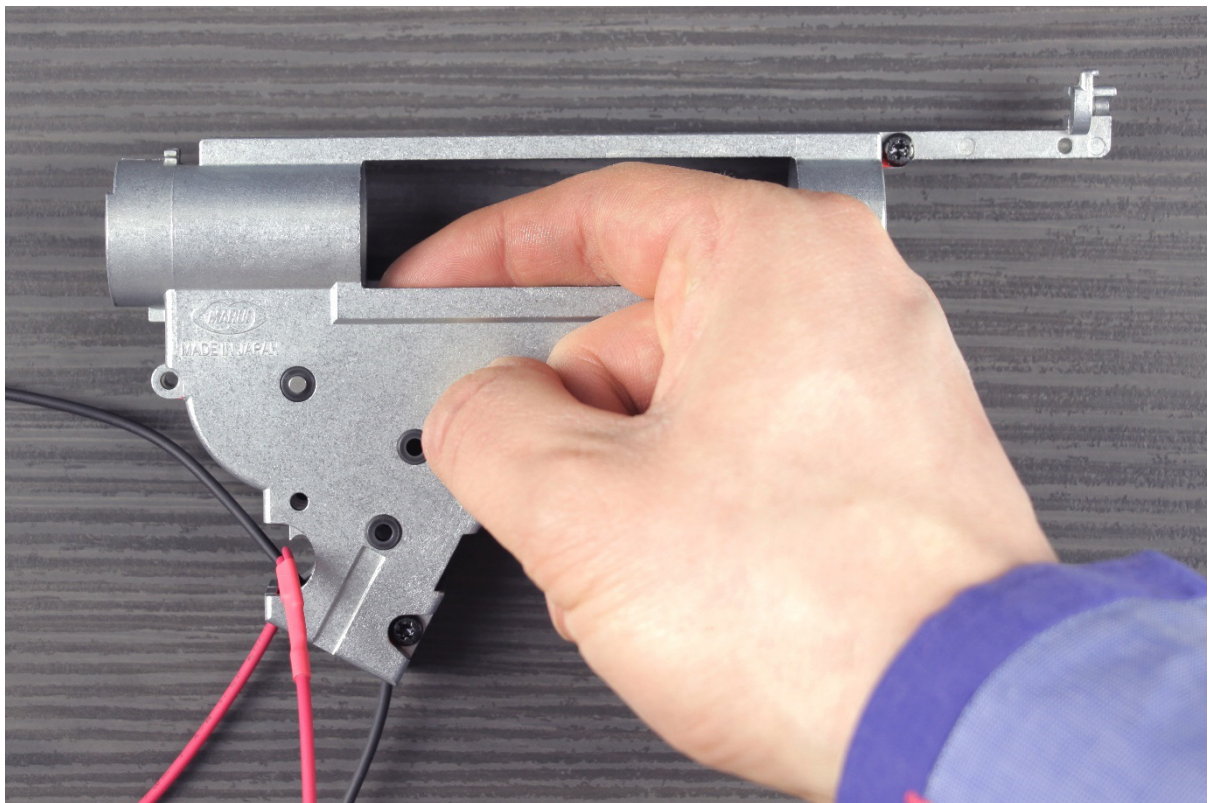

19. Depending on the position of the gear, the FULL SECTION/HALF SECTION icons should flash alternately. The gear sensors should also flash alternately.

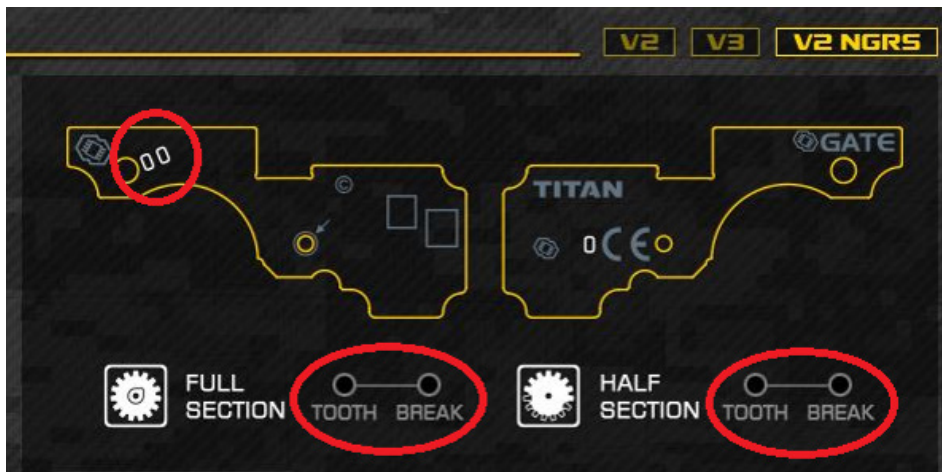

20. Test the bolt catch sensor by moving the lever up and down. Observe what happens with the BOLT CATCH SENSOR icons. Depending on the position of the lever, the icons should flash alternately.

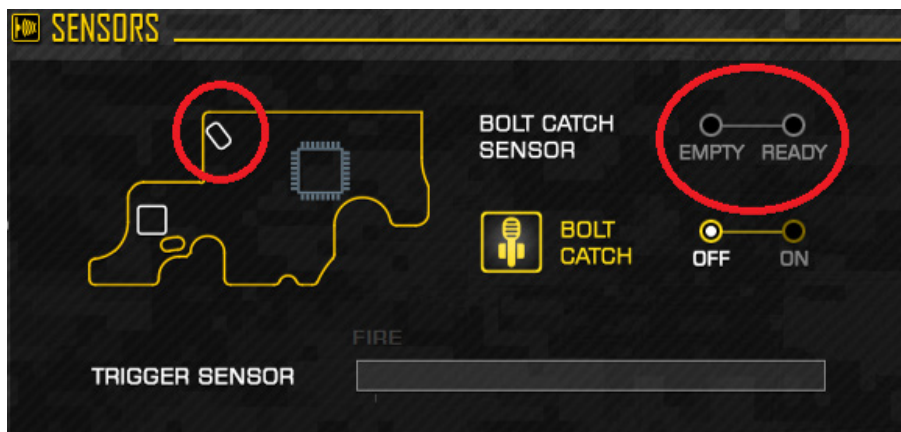
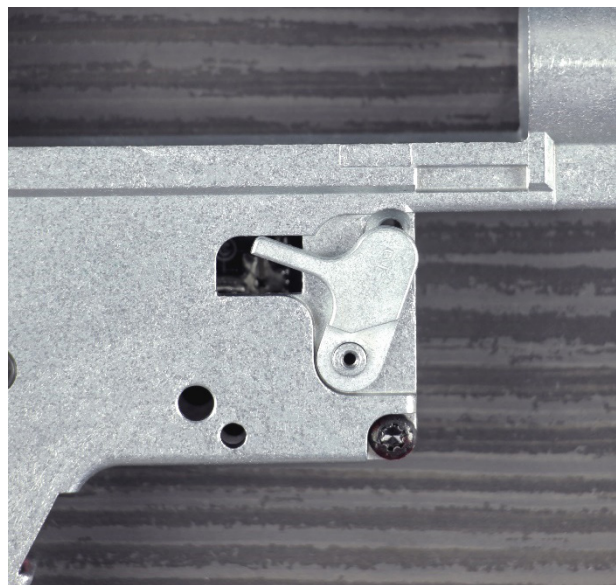
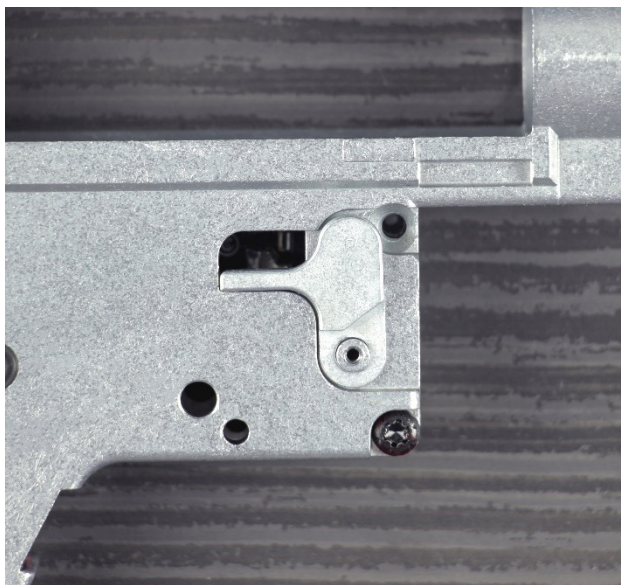



21. If both sensors work flawlessly, you can assemble the gearbox. Do not use too much grease. In a critical situation, excessive grease may cover a sensor.

22. Modify the fire selector plate. Use solvent to clean fire selector plate. Next, take the stickers shown in the picture below. Take the small sticker (fire selector sticker) and paste on the flat surface shown below.

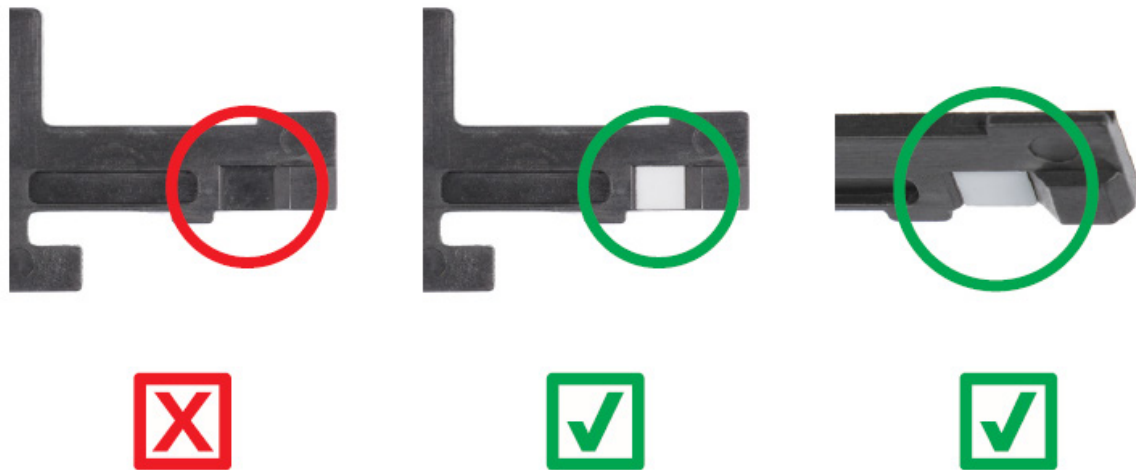

23. The wires in pistol grip have to be placed according to the photo below.



24. The wires in buffer tube have to be placed according to the photos below.

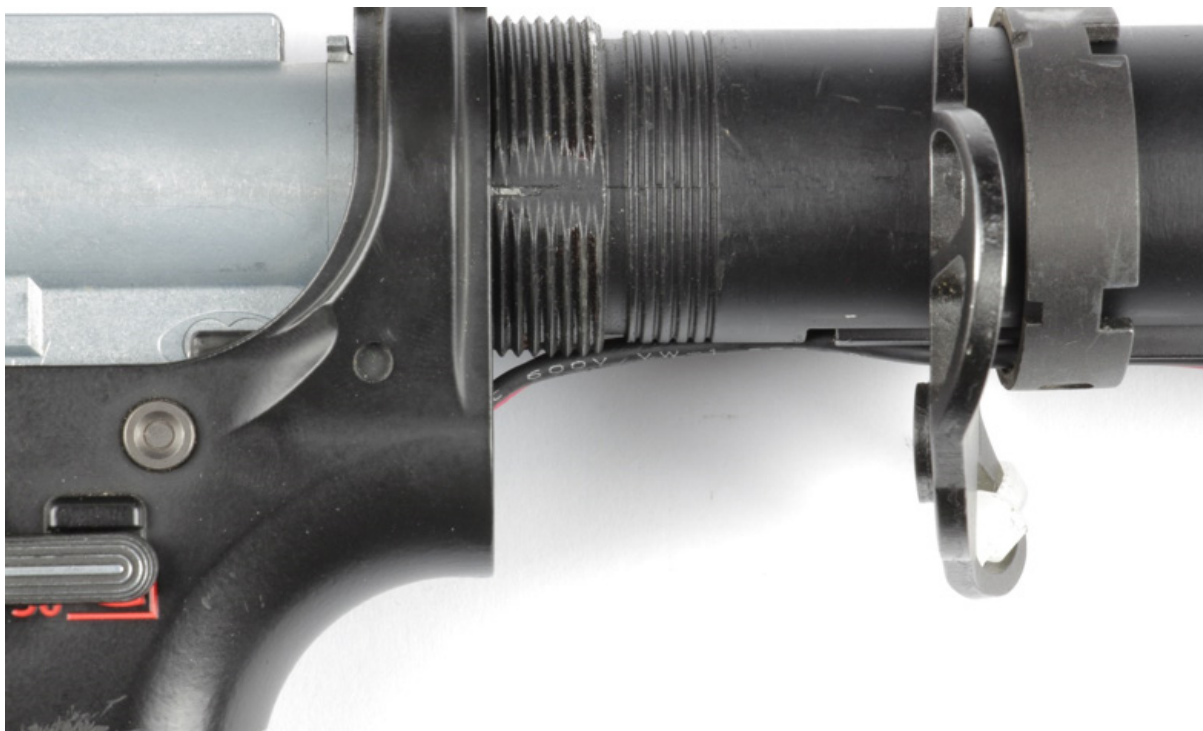



### Warning

Pay attention to correctly solder positive and negative TITAN wires to the connector. Otherwise, after plugging the battery, the reverse battery polarity will cause immediate damage to the device. Is not covered by the warranty and it can lead to fire, burn or even battery explosion.

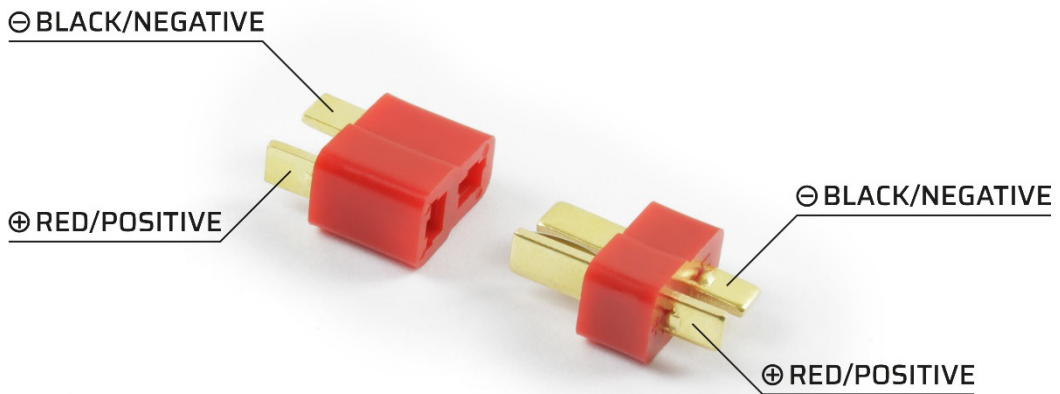

25. Put heat-shrink tube on a wire, cover the connector with a thin layer of solder (always use flux or rosin during soldering, especially when solder melts. This is necessary to achieve the correct connection).



26. Have a look at the connection and check if it is done properly. Pay attention to solder – it should fill soldered space correctly and solder should not be oxidized. Remove excess rosin from the connection.



27. Repeat the procedure with black (negative) wire.

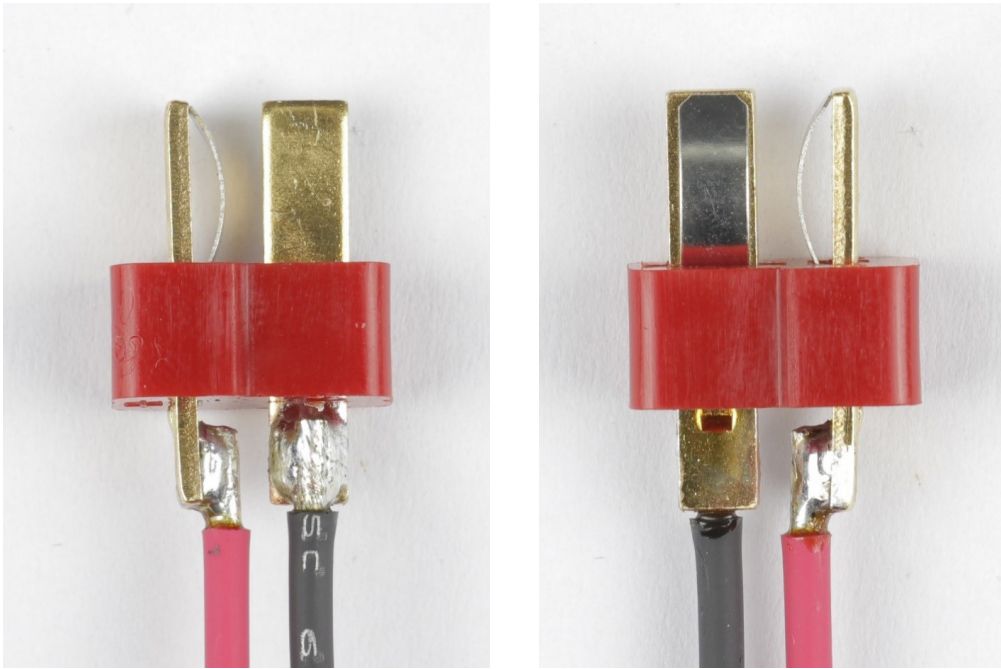

28. Prepare the heat-shrink tubes and close them. Heat each heat-shrink tube carefully from all sides. Do it over the flame of a gas range or lighter.

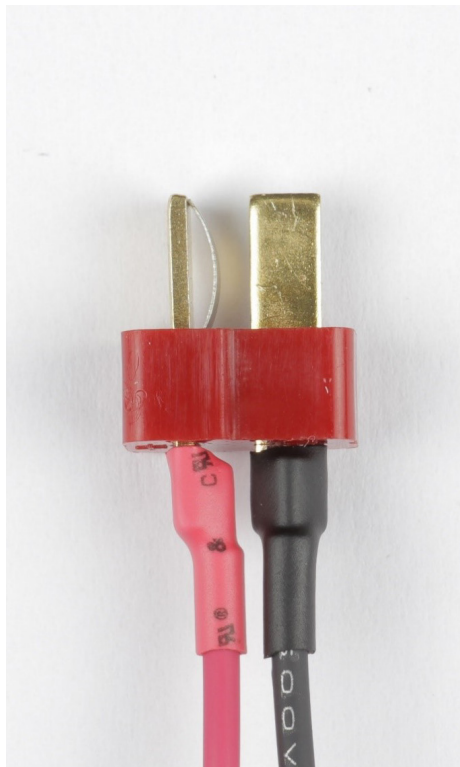

29. If your gun is completely assembled, perform the sensor calibration. Go to Sensors TAB in GATE Control Station and calibrate the trigger.

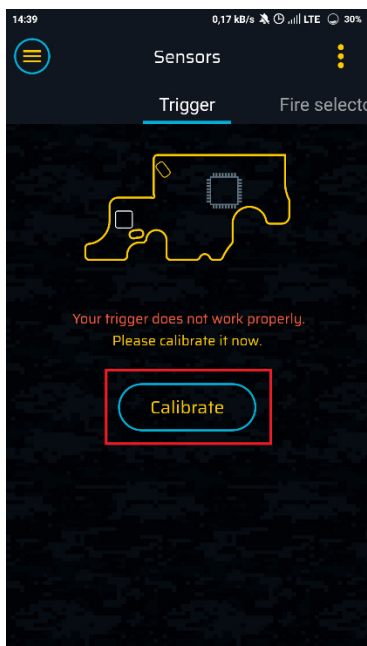

30. Then calibrate the fire selector.

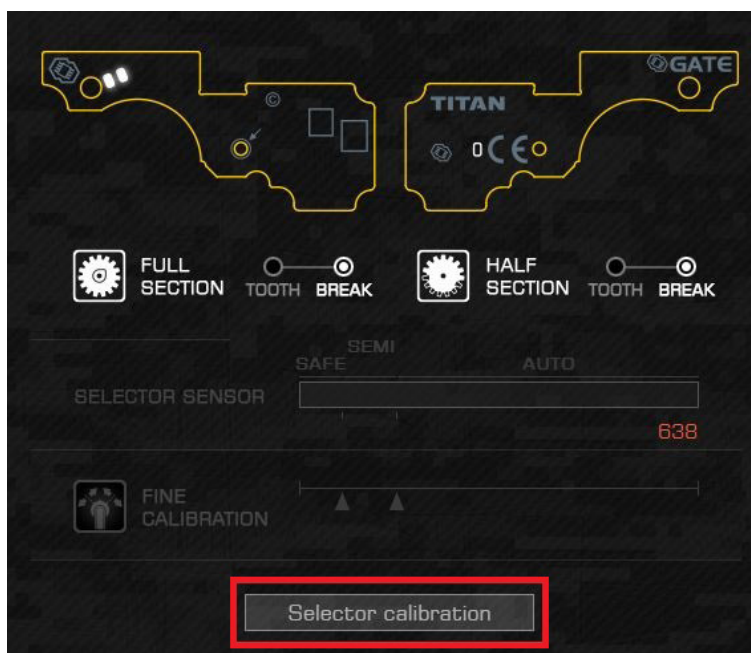
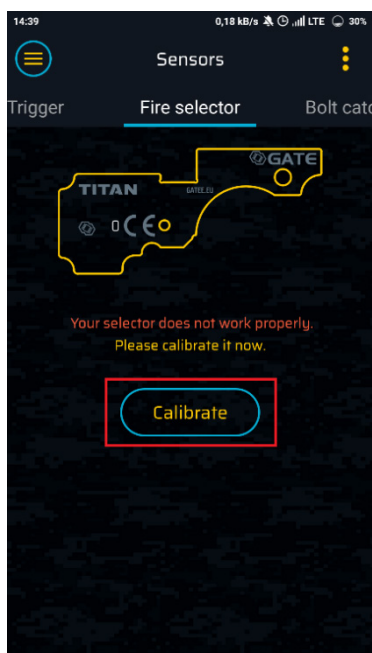

31. After successful calibration your AEG is ready to use.

# 9. Functions

## TRIGGER SENSITIVITY ADJUSTMENT

Trigger sensors allow you to control trigger sensitivity. You do not have to disassemble your AEG. Just use the GATE Control Station app to adjust the trigger to your preferences and level of skills.

## CONFIGURABLE FIRE SELECTOR (gen.2)

Two selector sensors allow you to use up to six fire selector modes, including innovative SEMI-BURST-AUTO mode:

- SAFE-SEMI-AUTO
- SAFE-SEMI-SEMI
- SAFE-SEMI-BURST
- SAFE-BURST-AUTO
- SAFE-SEMI-BURST/AUTO (short press - BURST, long press - AUTO)
- SEMI-BURST-AUTO (SAFE mode via the fast switch SAFE-SEMI-SAFE)\*

\*available only for TITAN V3 and V2 NGRS and only after modifications.

## CYCLE DETECTION

Thanks to the gear sensor(s), TITAN precisely detects in which position the cycle should finish. Therefore, even the shortest trigger action produces at least one full cycle. Thanks to the cycle detection function you get:

- Automatic BURST – there is no need to set the burst time.  
You can set the burst between two and 10 shots
- Automatic PRE-COCKING – Pre-cocking is fully operational in SEMI, BURST and AUTO modes. You can simply set the pre-cocking as high, mid or low;
- Full cycle - when the pre-cocking is off, TITAN ensures that the gearbox completes a full cycle. You gain a higher reliability.

## PRE-COCKING (gen.2\*)

Victory in the game is often a matter of fractions of seconds. Thanks to PRE-COCKING, you gain a trigger reaction similar to a real gun. It allows for initial spring compression, which speeds up the trigger response significantly.

There are two PRE-COCKING MODES:

- AUTO MODE – the spring is automatically compressed after each shot
- TRIGGER MODE – slow trigger action compresses the spring, and fast trigger action fires the shot.

There are also three PRE-COCKING BOOST options: HIGH / MID / LOW.

\*Now the pre-cocking is fully operational in SEMI, BURST and AUTO modes and there is no need to set the pre-cocking boost manually.

You can change Pre-cocking setup via fire selector\*. Now you do not need to fire the shot to switch pre-cocking mode. You can do it in two ways:

- a) Switch fire selector to SAFE and pull the trigger
- b) Switch fire selector to SEMI, fire the shot and keep the trigger pulled

While the trigger is pulled you are able to select pre-cocking mode:

- SAFE = Pre-cocking OFF
- SEMI = Pre-cocking SMART
- AUTO = Pre-cocking AUTO.

\*You can turn off this feature by marking off “SEL” button.

Please note: using PRE-COCKING increases wear and tear on the gearbox.

## **BURST (gen.2\*)**

The burst enables you to shoot a pre-determined number of BBs, which is very useful in MILSLIM and when using low-caps. The BURST mode is available after setting the proper fire selector mode. There are two BURST modes:

- FULL – every, even the shortest trigger action fires the pre-determined number of rounds.
- TRIGGER – releasing the trigger while firing stops the burst sequence.

\* There is no need to set burst time. You can easily set burst between two and 10 shots.

## **ROF CONTROL**

This enables a reduction in a gun’s rate of fire. You use stronger LiPo batteries, and still have a ROF just like in a real gun.



## **ROF STAB**

It allows you to change the way the ROF Control works:

- ON - ROF Control uses PWM (Pulse Width Modulation) to decrease ROF. Thanks to this, gearbox works smoothly what decreases wear and tear of AEG internal parts.
- OFF - ROF Control adds breaks between shots to decrease ROF. It gives you more realistic experience.

## **SNIPER DELAY**

It lets you to set delay between each SEMI shot to simulate the delay from reload or recoil. You can set 0.5s, 1s, 2s or 3s delay. You can enable vibration which will inform you when the gun is ready to shoot again by choosing "VIB" option.

## **SMART TRIGGER**

We know how vital the fast trigger response is during combat. This is why we have developed the Smart Trigger function. It enables you to achieve a faster trigger response. It works with the ROF Control System. During the first shot, the microprocessor sets the ROF Control to 100%. After the first shot, it switches to a previously programmed value (e.g. 50%). As a consequence, the first shot is fired at a full ROF, and subsequent shots at a reduced ROF. The best results can be achieved by using a battery with a higher than standard voltage. For example, if you use a 7.4V battery, you can replace it with 11.1V. In this way, you will achieve a faster trigger response with the same rate of fire as with a standard battery.

\*Works only when ROF STAB is ON.

## **TWO STAGE TRIGGER**

Enjoy two stage trigger. Activate 2-STAGE trigger mode and set two different trigger sensitivities. Pulling the trigger slightly produces SEMI or BURST fire and pulling the trigger further produces BURST or AUTO fire (depending on the fire selector mode).

## **BATTERY PROTECTION (gen.2\*)**

Protection against over-discharge of the battery. Modern LiPo and LiFe batteries are very sensitive to over-discharge. If you do not want to damage the battery and you care about its service life, this protection is indispensable. The microprocessor monitors the battery voltage constantly. When the voltage drops down to a critical level, it will not allow firing.

\*TITAN detects the number of cells automatically. There is no need to reprogram TITAN every time you replace the battery.

## **LOW BATTERY Warning**

When the battery voltage drops to the specified level (in relation to one cell), the motor will vibrate. You can set: OFF, 3.2V or 3.4V per cell.

## **SMART FUSE**

We have developed an electronic fuse with an accurate current sensor. A combination of current, voltage and temperature measurements makes your AEG installation highly reliable. It protects the MOSFET against overheating, overloading and short-circuiting. If your airsoft gun becomes jammed, the function protects the motor and battery against damage.

## **ADAPTIVE ACTIVE BRAKE**

It automatically adjusts the motor's braking power according to your needs. This prolongs the lifespan of the motor. Now you can also choose your own value depending on your needs.

## **MOSFET**

Do you want to achieve a higher ROF and faster trigger response? Are you planning a power upgrade of your gun? In that case, you need a MOSFET. It targets the energy from the battery directly to the motor, bypassing the mechanical trigger contacts. As a result, you gain a higher ROF of the gun and a faster trigger response.

## **BUILT-IN SELF-TEST**

This allows you to quickly check whether the TITAN is working properly. If any problem occurs, the Diagnostic Trouble Codes will indicate where the problem lies.

## **COATING**

Thanks to its special conformal coating, the unit is resistant to atmospheric conditions (Military Specification: MIL-V-173C).

## **DEANS-T READY\***

The product has factory-fitted low-resistance deans-t connector.

\*except TITAN V2 NGRS

## **14.8V LI-PO READY**

The TITAN can be used with batteries up to and including 14.8V LI-PO. The minimum operating voltage is 3.75V and maximum is 17V.

## **PRINTED QUICKSTART**

Make your adventure start more easily with a new product. The quickstart contains basic information and hints.

## **TRIGGER SENSITIVITY**

Allows you to adjust the trigger to your preferences and level of skills.

## **30-ROUND LIMIT**

An AEG can continuously fire max. 30 BBs. To fire more BBs, you must release the trigger before. This is a protection against trigger jam. Important: in case of an emergency, you can also stop firing by switching the fire selector position.

## **GEAR RATIO**

To make the PRE-COCKING working with the highest level of precision you should define the gears type in your AEG. Available types: STANDARD, HIGH TORQUE, HIGH SPEED, DSG, 19-TOOTH.

## **EQUALIZER (dynamic trigger point)**

- OFF - to fire a next shot, you need to release the trigger until it reaches the selected trigger sensitivity level
- 2LVL - to fire a next shot, it is enough to release the trigger so as it changes the state of two trigger sensors or ~40% of trigger movement
- 1LVL - to fire a next shot, it is enough to release the trigger so as it changes the state of one trigger sensor or ~20% of trigger movement

1LVL or 2LVL is especially useful when the trigger sensitivity level is very high. Then you do not need to fully release the trigger while quickly firing on SEMI.

# 10. Legal Notice

Please read the Legal Notice before operating your device and keep it for future reference. This document contains important terms and conditions with respect to your device. By using this device, you accept those terms and conditions.

## **EXCLUSION OF LIABILITY**

GATE Enterprise spółka z ograniczoną odpowiedzialnością sp. k. is not liable for any damages, injuries or accidents of any kind resulting from the use of this product or airsoft gun with the product installed, including (but not limited to) incidental or special damages to airsoft gun, airsoft gun parts, batteries and gearbox internals.

## **DISCLAIMER**

GATE Enterprise spółka z ograniczoną odpowiedzialnością sp. k. takes no responsibility regarding compliance of the product with the requirements of any law, rule or airsoft restrictions pertaining thereto.

## **INTELLECTUAL PROPERTY**

Intellectual Property owned by GATE Enterprise spółka z ograniczoną odpowiedzialnością sp. k., including but not limited to, devices, accessories, parts, software, documentation, is proprietary to GATE Enterprise spółka z ograniczoną odpowiedzialnością sp. k. and protected under Polish laws, EU laws, and international treaty provisions. You may not violate the rights of the Intellectual Property and you will not prepare derivative works of or reverse engineer the device or software. No ownership in the Intellectual Property is transferred to you.

## **GATE LIMITED WARRANTY POLICY**

GATE Enterprise spółka z ograniczoną odpowiedzialnością sp. k. warrants that its Product is free from manufacturing and material defects at the date of purchase and for a period of one (1) year from the date of purchase and it is nonextendable. This Limited Warranty is conditioned upon proper use of Product by Purchaser.

1. This Limited Warranty is valid provided that the owner provides a proof of purchase and properly completed warranty form.
2. This Limited Warranty does not cover: (a) defects or damage (e.g. mechanical, thermal or chemical) resulting from accident, misuse (misinterpretation of the instructions), abuse, neglect, unusual physical, electrical or electromechanical stress, water immersion, repairs or structural modification of any part of Product, or (b) the Product that has the serial number removed or made illegible; (c) defects or damage from improper operation, maintenance or installation, (d) installation of the products.
3. Requests for warranty are processed as soon as possible, not exceeding seven (7) working days. The company's obligation under this Limited Warranty shall be limited to providing replacement of part/s only



## PRODUCT DISPOSAL INSTRUCTIONS

The symbol shown here means that the product is classed as Electrical or Electronic Equipment and should not be disposed with other household and commercial waste at the end of its working life. The Waste of Electrical and Electronic Equipment (WEEE Directive 2012/19/U) has been put in place to recycle products using best available recovery and recycling techniques to minimize the impact on the environment. Purchasers shall take any old electrical equipment to waste recycling public centers or points of sale.



## CERTIFICATE OF CONFORMITY

GATE TITAN V2, GATE TITAN V3, GATE TITAN V2 NGRS and GATE USB-Link are in conformity with the essential requirements of the following Directives: EC DIRECTIVE 2011/65/EU. The products have been certified as RoHS Compliant.



### GATE Enterprise Sp. z o.o. Sp. k.

Torowa 3H  
PL-30435 KRAKÓW

Email: [office@gatee.eu](mailto:office@gatee.eu)  
Tel: (+48) 122-100-523  
[www.gatee.eu](http://www.gatee.eu)

